



banner not included



2 + 6
price for this combination
27,-

postfix

MADE IN EU design by KD

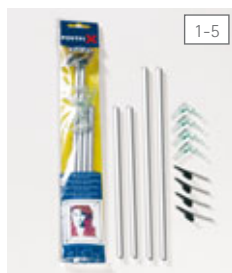

1-5

profilo ovale in alluminio anodizzato, 4 trasparenti angoli in policarbonato e morsetti a coccodrillo con molla.

ovales profil aus silbereloxiertem aluminium, vier verbindungssecken aus transparentem polycarbonat und krokodilklemmen mit feder.

oval silver anodized aluminium profile, 4 transparent polycarbonate connectors and croco clips with spring



6

POSTFIXFGARset set 1x4pcs

fissaggi in ottone cromato color argento satinato con anellini trasparenti, per il fissaggio a parete o su cavi di acciaio in confezione a 10 set di 4 pezzi l'uno, completi di viti e tasselli per il montaggio

halter aus silber matt verchromtem messing mit transparenten o-ringen, zur befestigung an wand und seil, konfektion 10 set à 4 stück, komplett mit schraube und dübel

spacers in silver matt chrome plated brass with transparent o-ring, for wall and cable mounting, box with 10 set with 4 pieces each, screws and dowels included

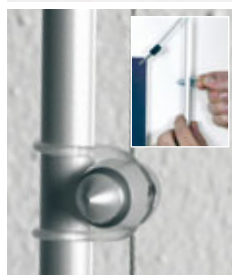

IT la combinazione di profili in alluminio anodizzato color argento, angoli in policarbonato trasparente e morsetti a coccodrillo è ideale per informazioni che vengono cambiate con una certa frequenza. per messaggi pubblicitari, foto, immagini ma anche come elemento decorativo per esporre tessuti, postfix fa al caso vostro. gli accessori consentono il montaggio a parete, a soffitto, su vetro, su cavi di acciaio o l'uso da banco.

DE kombination aus silber eloxiertem aluminium, transparenten polycarbonatecken und krokodilklemmen, genau das richtige für information, die unkompliziert gewechselt werden soll. für info- und bildmaterial oder als dekoelement mit stoffen oder folien. mit zubehör für counter, wand, spannsel und glas.

EN combination of silver anodized aluminium profiles with transparent polycarbonate connectors and alligator clips, the right choice for information that can be changed easily. not just information and images, but also as decorative element with fabric. accessories for counter, wall, suspension or glass.

postfix

n° articolo artikelnr. product nr.	structure	
1 POSTFIXA4	A4, 1pc	13,00€
2 POSTFIXA3	A3, 1pc	14,00€
3 POSTFIXA1	A1, 1pc	19,00€
4 POSTFIX700500	700mm x 500mm, 1pc	17,00€
5 POSTFIX1000700	1000mm x 700mm, 1pc	20,00€
accessory		
6 POSTFIXFGARset	spacers for wall and cable, set 1x4pcs	13,00€



for the ceiling ... wall and on the table

IT postfix è ideale anche per il fissaggio a parete o a soffitto, grazie agli accessori della serie loop, sviluppata come sistema modulare, dove sia sempre possibile aggiungere nuove parti e creare nuove configurazioni. oltre che per applicazioni a parete, postfix loop consente anche di realizzare divisori di spazio e separatori trasparenti con cui arredare lo showroom, l'ufficio o il negozio.

DE postfix ist ideal für decken- oder wandabhängung. mit den befestigungen der loop serie geht alles ganz einfach und wir haben das loop-system so gebaut, dass sie jederzeit um neue module erweitern können. ideal ist postfix mit loop nicht nur für die wandgestaltung. auch transparente raumteiler und luftige trennwände lassen sich schnell für showroom, office und shop gestalten.

EN postfix is perfect for suspending from the wall or ceiling. mounting is no problem with the fasteners of the loop series. we made the loop system modular so that it can be enlarged anytime you want. postfix with loop is not only the perfect way to fashion walls but also ideal to design transparent room dividers and breezy partitions in showroom, office and shop.

postfix

n° articolo artikelnr. product nr.	accessories	
7	FROS25CMset mounting support on glass, 4pcs	7,00€
8	POSTFIXBG steel support for counter, only A4 and A3	5,80€
9	AVEN4040set suction cups, 4pcs	5,80€
10	YLOOPARset fly loop silver, set 1x2pcs	11,70€
11	YL18110AR fly loop lot, 1pc	15,00€

FROS25CMset set 1x4pcs

rosett: sistema di montaggio su vetro con biadesivo o colla, in ottone cromato, per superfici lisce, confezione a 10 set di 4 pezzi l'uno
 rosett: aufklebbare befestigungshilfe messing verchromt, für glatte oberflächen, box mit 10 sets à 4 st

rosett: mounting support to glue on chrome-plated brass, for smooth surfaces, box with 10 sets with 4 pcs each.



POSTFIXBG

espositore da banco: cavo in acciaio inox, Ø3mm, 190mm, adatto solo per postfix A3 verticale e A4 orizzontale e verticale
 tischaufsteller: bügel aus niro edelstahl, Ø3mm, 190mm, nur für A3 vertikal, A4 horizontal und vertikal
 for counter and table: stainless steel support, Ø3mm, 190mm, use only with postfix A3 vertical, A4 horizontal and vertical



AVEN4040set set 1x4pcs

ventose trasparenti, Ø40mm, per il fissaggio su superfici lisce, in confezione a 10 set di 4 pezzi l'uno
 transparenter saugnapf, Ø40mm, für die befestigung auf glatten oberflächen, box mit 10 sets à 4 stk
 transparent suction cup, Ø40mm, for mounting on plain surfaces, box with 10 sets with 4pcs each

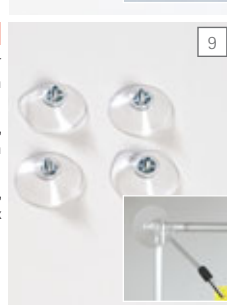

YLOOPARset set 1x2pcs

tirante per cavi fly loop per fissaggio a soffitto. ottone color argento satinato, per cavi di acciaio con spessore max. ø2mm, materiale di montaggio incluso

seilhalter fly loop für die deckenmontage. silber veredeltes messing, für stahlseile max. ø2mm, inkl. montagematerial.

cable fastener fly loop for ceiling. silver plated brass, for cables max. ø2mm, mounting material incl.

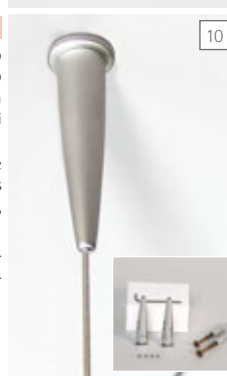

YL18110AR

loop lot YL18110AR in ottone cromato color argento satinato assicura la giusta tensione ed il giusto peso nella parte inferiore della struttura

das gewicht loop lot YL18110AR aus silbermatt verchromtem messing sorgt für die richtige spannung

loop lot YL18110AR made of silver matt chrome plated brass gives the required weight to the suspension system





3
bannerblock 1000mm
30,90

bannerblock

MADE IN EU design by KD

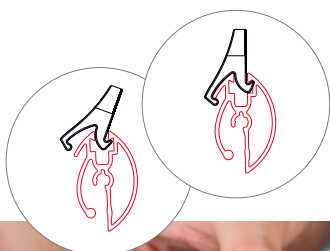

- 1-6 BBC500 per/für/for 500mm
- BBC700 per/für/for 700mm
- BBC1000 per/für/for 1000mm
- BBC1200 per/für/for 1200mm
- BBC1500 per/für/for 1500mm
- BBC2000 per/für/for 2000mm

profili in alluminio anodizzato color argento, tappi laterali e occhielli in materiale plastico, chiavetta per aprire il profilo.

silber eloxierte aluminiumprofile mit kunststoff-kappen und -klippösen sowie profilöffner

silver anodized aluminium profiles with synthetic caps, eyelet clips and profile opener

IT bannerblock è indubabilmente IL profilo per le vostre stampe digitali. i due profili in alluminio anodizzato color argento tensionano perfettamente le vostre stampe con spessori da 0,2 a 0,7mm, lungo tutto la loro lunghezza. gli occhielli in materiale plastico per il fissaggio a soffitto sono compresi nel set di profili, ai quali possono venir semplicemente agganciati con un clic. I formati più comuni sono disponibili a magazzino come set completi anche con occhielli e chiavetta per aprire il profilo, mentre per le vostre esigenze fuori standard ci sono le barre a metro

DE DAS klemmprofil für ihre digitaldruckpräsentation. silber eloxierte aluminium profile klemmen drucke von 0,2 bis 0,7mm auf ganzer länge sicher ein. kunststoffösen für die deckenabhängung sind im lieferumfang dabei und können einfach eingeklipst werden. bannerblock gibt es in gängigen längen als doppel-set inclusive ösen und praktischem profil-öffner.

EN THE profile for your digital print presentation. silver anodized aluminium extrusions clamp the full length of your prints with thicknesses from 0,2 to 0,7mm. the synthetic eyelets included for suspension from ceiling can be simply clipped on. bannerblock is available in common lengths as 2 piece set with eyelets and convenient profile opener.

bannerblock

n° articolo artikelnr. product nr.	structure	
1 BBC500	for 500mm	18,40€
2 BBC700	for 700mm	23,90€
3 BBC1000	for 1000mm	30,90€
4 BBC1200	for 1200mm	35,90€
5 BBC1500	for 1500mm	41,90€
6 BBC2000	for 2000mm	52,90€

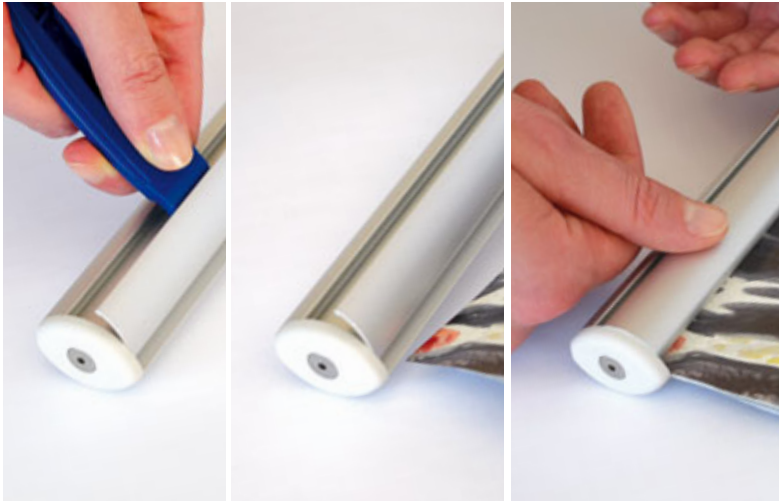

wall support

MADE IN EU design by KD 

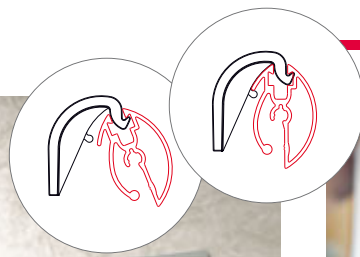

bannerblock wall support

n° articolo artikelnr. product nr.		
1	BBWS	bannerblock support 1pc 5,00€

BBWS
 fissaggio a parete per bannerblock, in materiale plastico di colore grigio, materiale per il montaggio incluso. bannerblock, con o senza la stampa, può essere agganciato o sganciato in qualsiasi momento.
 wandbefestigung für bannerblock, kunststoff grau inkl. montagmaterial. bannerblock mit und ohne banner kann jederzeit einfach ohne werkzeug ein- und ausgehängt werden.
 wall support for bannerblock, grey synthetic incl. mounting material. bannerblock with or without banners can be easily attached anytime without further tools.

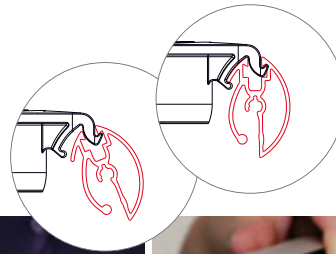

semplice da agganciare all'asta telescopica, senza viti o utensili
 einfach einklippen, ohne schrauben und werkzeug
 simply clip on, no screws or tools needed

praticità: gancio in materiale plastico per presentazioni mono- e bifacciali
 praktisch: ein halter für einseitige und doppelseitige präsentation
 convenient: just one support for single and double side presentations

bannerboy restyle

MADE IN EU design by KD

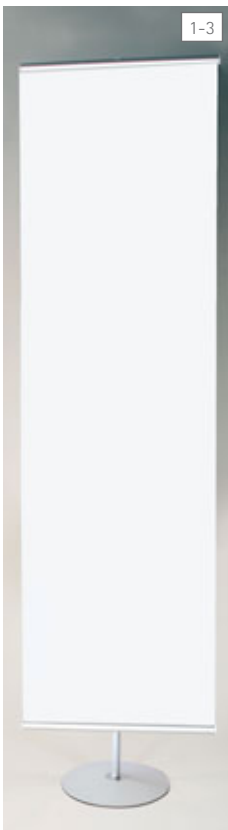

- BABN500 per/für/for 500mm
- BABN700 per/für/for 700mm
- BABN1000 per/für/for 1000mm

profili bannerblock in alluminio anodizzato color argento, asta telescopica, base in materiale plastico color grigio chiaro, borsa per il trasporto inclusa.

silber eloxierte aluminium profile bannerblock, teleskopstange, basis aus lichtgrauem kunststoff, incl. tragetasche

silver anodised aluminium profiles bannerblock, telescopic bar, base made of light grey synthetics, transport bag incl.



IT bannerboy è il pratico display pronto per l'uso per le vostre stampe digitali mono- o bifacciali. il banner si tensiona in modo molto semplice grazie ai profili, i quali si agganciano poi altrettanto semplicemente all'asta telescopica. per una presentazione bifacciale, basta solo ordinare un ulteriore set di profili bannerblock nella lunghezza desiderata. il set bannerboy viene fornito con una pratica borsa, da utilizzare per il trasporto e lo stoccaggio del portabanner.

DE bannerboy display mit klemmprofil bannerblock für ein- und beidseitige digitaldruck präsentation. banner einfach mit den klemmprofilen montieren und an die struktur anklipsen. für die doppelseitige präsentation einfach ein weiteres set bannerblock in der gewünschten länge bestellen. die praktische tragetasche schützt ihren bannerboy bei transport und lagerung.

EN bannerboy display with clamp extrusion bannerblock for single and double sided digital print presentation. simply mount the banner to the extrusion and clip it to the structure. for a double side presentation simply order another set of bannerblock in the requested length. the convenient bag protects your bannerboy during transport and storage.

bannerboy



n° articolo artikelnr. product nr.		structure + bannerblock	
1	BABN500	for 500mm	103,40€
2	BABN700	for 700mm	108,90€
3	BABN1000	for 1000mm	115,90€
bannerblock			
4	BABBC	bannerboy connector clip, 1pc	3,90€
5	BBC500	bannerblock 500mm	18,40€
6	BBC700	bannerblock 700mm	23,90€
7	BBC1000	bannerblock 1000mm	30,90€



2

bannerboy 700

108,90



BABBC

connettore a clip per presentazioni bifacciali, in materiale plastico color grigio chiaro

connector clip für doppelseitige präsentation, kunststoff lichtgrau
connector clip for the double side presentation, plastic light grey



4

- BBC500 per/für/for 500mm
- BBC700 per/für/for 700mm
- BBC1000 per/für/for 1000mm

profili in alluminio anodizzato color argento, tappi laterali e occhielli in materiale plastico, chiavetta per aprire il profilo
silber eloxierte aluminiumprofile mit kunststoff-kappen und -klippösen sowie profilöffner
silver anodized aluminium profiles with synthetic caps, eyelet clips and profile opener



5-7





bannerboy structure

 MADE IN EU design by KD



1
bannerboy 1300-2400mm
85,-



IT grazie a bannerboy e bannerblock potete addirittura costruire e formare vere e proprie pareti divisorie. proprio per questo utilizzo abbiamo realizzato e vi offriamo la struttura bannerboy. a seconda delle esigenze, potrete scegliere l'accessorio più adatto dal nostro assortimento bannerblock. se vi servono misure fuori standard, non esitate a chiedere, siamo volentieri a vostra disposizione.

DE sie können mit bannerboy und bannerblock auch modular wände bauen. dafür bieten wir ihnen hier die bannerboy struktur an. je nach bedarf wählen sie aus unserem bannerblock programm das benötigte zubehör. für ausserstandard längen fragen sie uns, wir beraten sie gerne.

EN you can build with bannerboy and bannerblock modular walls as well. for this we offer you the bannerboy structure. according to your needs choose freely from our bannerblock assortment of accessories. for non standard lengths please contact us directly.

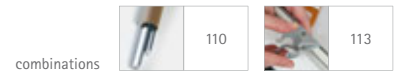

bannerboy

n° articolo | artikelnr. | product nr.

1 **BABN2400ELG** bannerboy structure, 1pc **85,00€**





pole 

MADE IN EU design by KD 



IT pole, asta telescopica pratica e versatile, vi sostiene in ogni vostra creazione. nella parte superiore l'asta telescopica è dotata di un filetto. a scelta la base può essere fornita nella versione personalizzabile con l'inserito centrale in vetro o con il rivestimento in materiale plastico color grigio chiaro.

DE pole kann als teleskopische struktur ihre kreativität unterstützen: oben ist die teleskopstange mit einem gewinde ausgestattet. beim standfuss können sie zwischen der personalisierbaren version mit glaseinsatz oder der lichtgrauen kunststoff-basis wählen.

EN pole the telescopic structure supports your creativity: on top of the telescopic bar you find a thread. for the base you can choose between the customizable version with glass inlay or the cover made of light grey synthetic.



1 pole 1300-2400mm

68,-

2 pole 1300-2400mm

61,-

pole

n° articolo | artikelnr. | product nr.

1	DPON2400VE	pole with glass inlay base, 1pc	68,00€
2	DPON2400LG	pole with light grey base, 1pc	61,00€



digi



banner not included



profilo bannerblock in combinazione con sidefix per sistemi in tensione su cavi di acciaio
 bannerblock in kombination mit sidefix für seilspannsysteme
 bannerblock in combination with sidefix for cable suspension systems

bannerblock®

MADE IN EU design by KD



1 **YSF1315ARset** 1x4pcs
 sidefix color argento fissaggio su cavi, confezione 10set con 4pz cad.
 sidefix silber bestigung für seilmontage, konfektion mit 10 set à 4st
 sidefix silver mounting support for cable, box 10set of 4pcs each



2 **YM3050ARset** 1x2pcs
 mobil color argento fissaggio a parete e soffitto per cavi, confezione 5set con 2pz cad.
 mobil silber decken- und wandhalter für seil, konfektion mit 5 set à 2st
 mobil silver ceiling- and wall-support for cable, box 5set of 2pcs each



3 **AFIL05** 5m
4 **AFIL25** 25m
5 **ABOB500** 500mm
 cavo di acciaio rot. 500m/25m/5m
 stahlseil rolle 500m/25m/5m
 steel cable roll 500m/25m/5m

IT bannerblock è ideale anche per applicazioni su cavi di acciaio. che si tratti di stampe singole o di composizioni modulari, grazie agli elementi della linea fly potrete integrare il vostro bannerblock e le vostre stampe digitali a qualsiasi sistema in tensione su cavi. fissate bannerblock al cavo di acciaio con sidefix. i teli si possono cambiare velocemente in qualsiasi momento. date un'occhiata al capitolo fly, dove troverete una vasta scelta di accessori per sistemi in tensione su cavi.

DE bannerblock bietet sich insbesondere auch für die montage von digitaldrucken am seilspannsystem an. ob einzelne drucke oder modulare gestaltung, mit den befestigungselementen der linie fly integrieren sie bannerblock und ihre digitaldrucke in alle informationsysteme am spannsel. mit sidefix befestigen sie die profile am seil. die drucke lassen sich jederzeit austauschen. schauen sie mal ins kapitel fly, dort finden sie eine umfassende auswahl für alles rund ums spannsel.

EN bannerblock is also ideal for mounting digital prints to cable rod systems. single prints or modular design, with the elements of the fly range you integrate easily bannerblock and your digital prints to all information systems on cable. mount the extrusions with sidefix to the cable. the prints can be exchanged anytime. have a look at the chapter fly, there you find a huge choice of fixings all about cable rod systems.

bannerblock

n° articolo | artikelnr. | product nr.

1	YSF1315ARset	sidefix silver, set 1x4pcs	13,30€
2	YM3050ARs	mobil silver, set 1x2pcs	29,80€
3	AFIL05	steel cable, roll 5m	8,60€
4	AFIL25	steel cable, roll 25m	19,50€
5	ABOB500	steel cable, roll 500m	181,00€



introdurre il materiale nel posterblock aperto
 material in den geöffneten posterblock einführen
 insert the image into the open posterblock



chiudere il posterblock esercitando una lieve pressione con un click
 posterblock mit sanftem klick schliessen
 smoothly click to close the posterblock

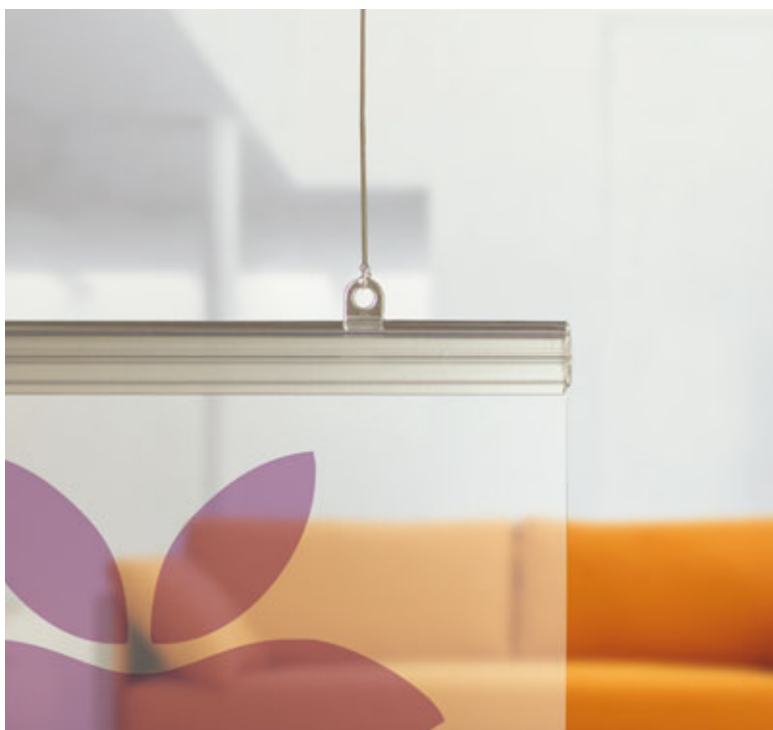

posterblock

MADE IN EU quality control by KD

IT cercate un'alternativa facile e veloce per poster, foto o informazioni in generale? posterblock è l'ideale per qualsiasi realizzazione grafica che abbia fino ad 1 mm di spessore. il profilo ad incastro in materiale plastico è disponibile trasparente o in colore nero. il fissaggio avviene in un batter d'occhio, sia a parete che a soffitto, grazie agli occhielli trasparenti da inserire nella parte superiore del profilo.

DE sie suchen eine leichte alternative für die präsentation von poster, foto oder information generell? posterblock ist das richtige für alle grafiken mit einer stärke bis zu 1mm. die klemmschiene aus kunststoff erhalten sie in schwarz oder transparent. mit den transparenten ösen zum einklicken an wand oder decke schnell befestigt.

EN looking for a lightweight way to present posters, images or information in general? then take posterblock and you are alright for images up to 1mm thickness. the snap-shut synthetic profile is available in black or transparent. click in the transparent eyelets and mount posterblock on wall or ceiling.



posterblock

n° articolo | artikelnr. | product nr.

1	PB3000SZ	profile black, 5pcs x 3000mm	92,00€
2	PB3000TR	profile transparent, 5pcs x 3000mm	92,00€
3	PBSET10	mounting set with eyelet and nylonthread, 10sets	11,90€
4	PBHK20TR	transparent eyelets, box 20pcs	6,90€

PB3000SZ 5pc x 3000mm

PB3000TR 5pc x 3000mm

profilo ad incastro in mat. plastico, 5 pezzi di 3m l'uno in col. nero PB3000SZ o trasparente PB3000TR kunststoffklemmprofil, 5stk à 3m in schwarz PB3000SZ und transparent PB3000TR

snap-shut synthetic profile, 5pcs with 3m each in black PB3000SZ and transparent PB3000TR

PBSET10 10 set

set per il fissaggio composto da 2 occhielli trasparenti e da 2m di filo in nylon, confezione a 10 set

befestigungs-set mit je 2 ösen transparent und je 2m nylonthread, konfektion mit 10 sets

mounting set with 2 transparent eyelets and 2m nylon thread each, box with 10 sets

PBHK20TR 20pcs

20pz occhielli per il fissaggio, in materiale plastico trasparente

20stk befestigungs-ösen, kunststoff transparent

20pcs eyelet for fastening, transparent synthetics





banner not included

tex wall

MADE IN EU design by KD



IT agganciare bannerblock alla ghiera, tenere il banner e fissare la ghiera sul tubo

DE bannerblock im ring einhängen, spannen und fixieren

EN attach the bannerblock to the ring, then tighten the banner and fix the ring



struttura modulare: combina il set base con il modulo di aggiuntivo
modulare bauweise - basis set mit erweiterungsmodule kombinieren
modular set up: combine the base set with the extension module

tex wall: banner 850x900 (hwxw).

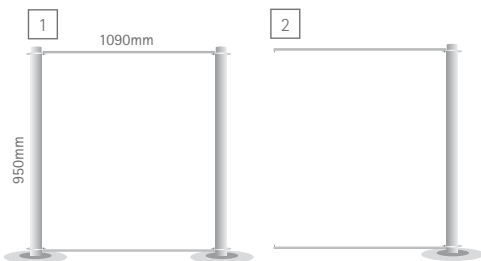

1 + 2
price for this combination

378,-

banner not included

IT presentazione con il sistema modulare texwall: tex wall abbina il sistema guidalinee tex con i profili ad incastro bannerblock. inserire i banner nei profili ed agganciarli. grazie ai supporti anulari, ogni modulo texwall può essere sistemato anche in maniera non lineare per creare pareti angolari o a „zigzag“. vi consigliamo gli accessori della serie tex anche per tex wall.

DE mit tex wall modular präsentieren: clevere kombi aus leitsystem tex mit klemmprofil bannerblock. banner in die profile einklemmen und einhängen. durch die ringförmigen halter, können sie jedes tex wall modul auch gewinkelt anfügen. unser tip: accessoires der stopper serie passen auch zu tex wall.

EN presentation with modular system tex wall: clever combination between queue management tex with bannerblock extrusion. clamp in the banner and simply attach it to the posts. thanks to the circular supports each texwall module can also be connected at angles. our tip: the accessories of the stopper range fit well tex wall also.

tex wall

n° articolo | artikelnr. | product nr.

1	TXW950	tex wall 950x1090mm, 1pc	229,00€
2	TXW950M	tex wall module 950mm h, 1pc	149,00€

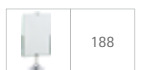



ima2go straight

MADE IN CHINA quality control by KD

diggi

IT il pop up dritto ima2go non è solo adatto per applicazioni standard, ma è particolarmente adatto quando si ha bisogno di vere e proprie pareti divisorie, anche bifacciali, grazie alla propria conformazione. grazie al sistema rapido con velcro per il fissaggio del banner e alla borsa per il trasporto siete sempre pronti e preparati per le vostre presentazioni. i faretti alogeni inoltre garantiranno sempre la migliore visibilità per le vostre immagini.

DE das gerade pop up ima2go straight empfiehlt sich neben den üblichen einsätzen in der präsentation v.a. auch als trennwand. mit mehreren pop ups lassen sich wände bauen, auch beidseitig mit rückseitiger ergänzung. mit klettverschluss für banner und transporttasche sind sie immer schnell im einsatz. zusätzlich können sie mit der passenden halogenlampe ihr motiv stets perfekt ausleuchten.

EN the straight pop up ima2go is not only perfect for the usual pop up application but is recommended especially as a partition wall. with more of them you can built walls, also double-sided. with the velcro for banner mounting and the transport bag you are always prepared for your presentation. additionally you can equippe your ima2go straight with our halogen lamps and light up your image always best.

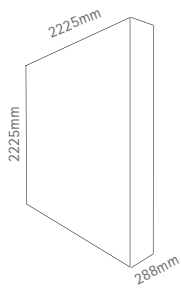

ima2go straight

n° articolo | artikelnr. | product nr.

1	DIMSTR3X3	ima2go straight, 1pc	235,00€
		spare parts for ima2go straight	
2	DIMVELCRO	spare part hook and loop, 1 roll	15,00€
3	DIMLPL	lamp, 1pc	59,00€

DIMSTR3X3

pop-up dritto e pieghevole, borsa per il trasporto inclusa

faltbares pop-up, gerade mit transporttasche

foldable straight pop-up, with transport bag

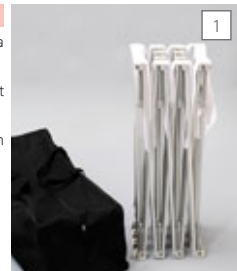

DIMVELCRO

accessorio di ricambio: velcro per il fissaggio del banner

ersatzteil: klettverschluss zur bannermontage

spare part: velcro for banner mounting



DIMLPL

faretti alogeni nero, orientabile e inclinabile, 150 W

schwarze halogen-stableuchte. schwenk- und drehbarer kopf, 150W.

150W halogen spot lights, in black, adjustable and directional

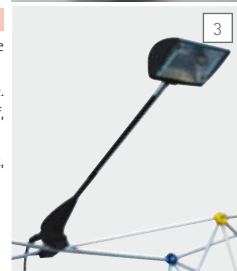



1
ima2go
599,-

banner not included



DIM4X3
pop-up curvo pieghevole, compreso trolley da trasporto
faltbares pop-up, gebogen mit transporttrolley
foldable curved pop-up, with transport trolley



ima2go bow

MADE IN CHINA quality control by KD



2 **DIMLP**
faretto alogeno nero, orientabile e inclinabile, 150 W
schwarze halogenstableuchte, schwenk- und drehbarer kopf, 150W.
150W halogen spot lights, in black, adjustable and directional



3 **DIM4X3ACAL**
pezzo di ricambio: biadesivo magnetico per il montaggio del banner
ersatzteil: magnetrolle mit doppelkleber zur bannermontage
spare part: magnetic double adhesive tape for banner mounting

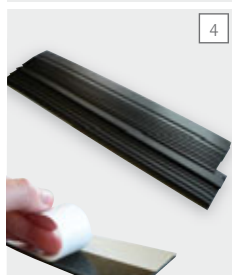

4 **DIM4X3HK**
pezzo di ricambio: strisce magnetiche biadesive per il montaggio del banner
ersatzteil: magnetische montagegestrips mit doppelkleber für die bannermontage
spare part: magnetic double adhesive hanging kits for banner mounting

IT ima2go, il muro pieghevole veloce e facile da montare in qualsiasi luogo, con sistema a griglie incrociate. fissare le strisce magnetiche autoadesive al banner, posizionare il banner sulla struttura ed è fatto. un handling semplice con un effetto grandioso, subito smontato, ideale per l'uso mobile nelle fiere, eventi, manifestazioni ed altre attività.

DE ima2go ist die überall einsetzbare faltwand, schnell und einfach in der montage mit gebogenem scherengittersystem. selbstklebende magnetstreifen am banner befestigen, banner auf die struktur legen, fertig. einfaches handling mit grandioser wirkung.

EN ima2go is the all purpose popup display. fix the selfadhesive magnetic stripes to the banner, then simply lay the banner on the structure and that's it. simple handling with great effect, easy and quick set-up, perfect for mobile use at fairs, events, presentations and promotions of all kinds.

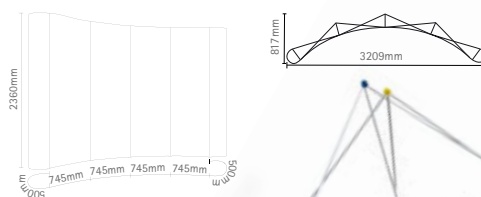

ima2go bow & standbyU

n° articolo artikelnr. product nr.			
1	DIM4x3	ima2go bow, 1pc	599,00€
accessories/spare parts for ima2go bow			
2	DIMLP	lamp, 1pc	59,00€
3	DIM4X3ACAL	magnetic roll, 1pc	69,00€
4	DIM4X3HK	hanging kits, 1set	39,00€



IT standbyU il counter promozionale per utilizzo mobile: personalizzabile facilmente con stampe, robusto e stabile, mobile e pratico.

DE standbyU der promo-counter für den mobilen einsatz: einfach mit druck zu personalisieren, robust und stabil, mobil und praktisch.

EN standbyU the promotional counter for mobile use: easily personalisable with print, robust and stable, mobile and practical.

ima2go bow & standbyU

11,0

n° articolo | artikelnr. | product nr.

1 DSTBU

standbyU, 1pc 144,00€



standbyU

MADE IN CHINA quality control by KD

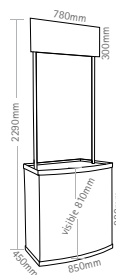

STANDBYU

promo-counter mobile e personalizzabile con stampa, sacca compresa

promo-counter für den mobilen einsatz und personalisierbar mit druck, incl. transporttasche

mobile counter for promotion, customizable with print, transport bag incl.



pratica zona di stoccaggio nel counter c'è molto spazio per depositare cataloghi, oggetti promozionali o altro materiale.

praktischer stauraum: im counter findet sich viel platz für kataloge, werbegeschenke oder anderes aktionsmaterial.

practical storage area: on the counter there is ample space to place catalogues, promotional material and other objects.

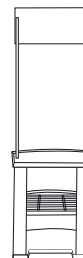

1
prouet vetrina
1313,40



print not included

DPIR2000

la struttura prouet include 4 pannelli bianchi e 4 trasparenti e l'illuminazione

prouet struktur incl. 4 weisser und 4 transparenter paneele, beleuchtung

prouet structure incl. 4 white and 4 transparent panels, lighting

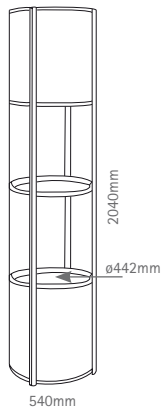

si monta con un semplice movimento, i pannelli si fissano in modo sicuro alla struttura grazie alle strisce magnetiche
mit einer bewegung aufstellen, paneele haften dank magnetverschluss sicher
sets up in one movement, panels hold safely thanks to the magnetic system

pirouet vetrina

IT prouet vetrina è un display mobile che può fungere da vetrina e porta comunicazioni. grazie ad un semplice movimento rotatorio si monta in un batter d'occhio senza utilizzare nessun utensile e altrettanto velocemente si smonta. quando prouet è ripiegata su se stessa occupa pochissimo spazio di stoccaggio. le pareti si montano velocemente grazie alle strisce magnetiche e altrettanto velocemente e semplicemente si possono personalizzare con stampe o vinili adesivi. le luci, incassate nella vetrina, vi consentono di avere la giusta illuminazione per la presentazione ideale dei vostri prodotti.

DE prouet vetrina ist ein mobiles display, das sie als vitrine und kommunikationsträger einsetzen können. es lässt sich mit einer einfachen drehbewegung ganz ohne werkzeug im nu aufstellen und wieder raumsparend zusammenfallen. die wände sind dank der magnetverschlüsse sofort montiert und werden einfach mit druck oder durch kaschieren personalisiert. die eingebaute leuchte setzt ihre produktpräsentation ins rechte licht.

EN prouet vetrina is a mobile display, that you can use as display cabinet and communication display as well. it sets up into place and folds down space-saving at once without any tools. the walls are mounted thanks to the magnetic systems in no time at all. you can customize the panels with print or laminate easily. the shelf includes a recessed light to illuminate your product presentation perfectly.

pirouet vetrina

15,4

n° articolo | artikelnr. | product nr.

1 DPIR2000

pirouet vetrina, 1pc **1313,40€**



si monta facilmente, con uno spazio deposito sul retro
 schnell aufgestellt, mit stauraum auf der rückeite
 quickly set up, with storage space on the rear side

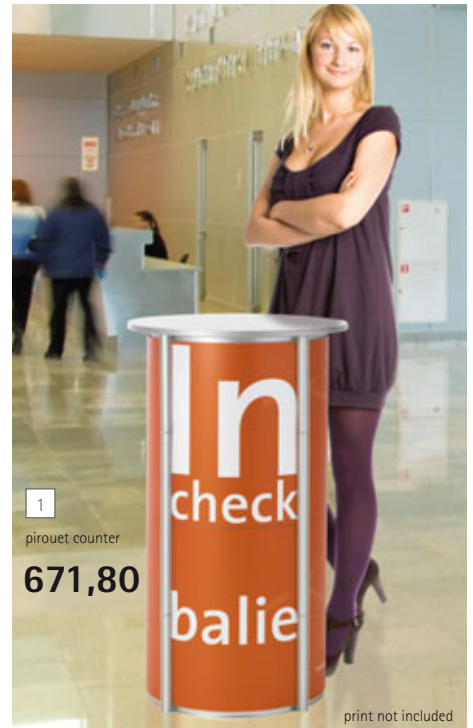

1
 pirouet counter
671,80

print not included

pirouet counter

IT pratico counter che si allestisce in una manciata di secondi e che, grazie alle pareti personalizzabili, si adatta ad ogni evento: ecco a voi pirouet counter! il tavolino top superiore è laccato in color grigio argento, nella parte posteriore c'è tantissimo spazio per mettere i vostri cataloghi, i campioni o le vostre documentazioni riservate. con la stessa velocità con cui lo avete allestito, altrettanto rapidamente pirouet counter si smonta e si richiude, facendovi risparmiare spazio e volume sia durante il trasporto che per lo stoccaggio a magazzino. in ogni caso, non avete bisogno di nessun utensile per usare pirouet counter, che si rivela un ottimo accompagnatore per eventi, saloni, fiere e roadshows.

DE ein praktischer counter, der sich in sekunden auffaltet und mit den personalisierbaren wänden zu jedem event passt, das ist pirouet counter. die top-platte ist silbergrau lackiert, auf der rückeite findet sich ausreichend stauraum. genauso schnell wie sie ihn aufgebaut haben, faltet sich pirouet counter wieder platzsparend für transport und lagerung zusammen. sie brauchen keinerlei werkzeug, ein idealer mobiler begleiter für events, messen und roadshows.

EN this is a real convenient counter, that sets up in seconds. it matches every event perfectly with the customizable wall panels. the table top is varnished silver grey, on the rear side you find enough storage space. as fast as you have set it up, the pirouet counter folds away, saving space for transport and storage. you need no tools at all, it is your perfect companion for events, fairs and road shows.

DPIR1000

struttura composta da 6 pannelli bianchi e tavolino top grigio argento
 struktur mit 6 weissen paneelen, silbergrauem top
 structure incl. 6 white panels, silver grey table top

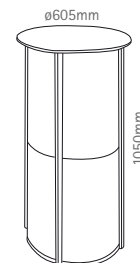

pirouet counter



n° articolo | artikelnr. | product nr.

1 **DPIR1000**

pirouet counter, 1pc **671,80€**



banner not included

1
ima2go tower
235,-

- 

2 **DIMLPLP**
faretto alogeno nero 150 W
schwarze halogen-leuchte 150W
150W halogen spot lights, in black
- 

3 **DIMTOWACAL**
per ricambio: biadesivo magnetico
ersatzteil: magnetrolle doppelkleber
spare part: magnetic adhesive tape
- 

4 **DIMTOWHK**
ricambio: strisce magnetiche
adesive per il montaggio del banner
ersatzteil: magnetische montage-
strips mit doppelkleber
spare part: magnetic double
adhesive hanging kits



ima2go tower

 MADE IN CHINA quality control by KD

IT il favoloso pop-up tower che farà da vera colonna alla vostra presentazione. estraendola dalla sua pratica custodia, l'ima2go tower si dispiega trasformandosi in colonna che supera l'altezza d'uomo. il banner viene rapidamente fissato mediante calamita. come optional per una perfetta illuminazione, potrete aggiungere una lampada DIMLPLP.

DE ima2go der tolle pop - up tower - eine echte säule ihrer präsentation. aus der praktischen tragetasche entfaltet sich der ima2go tower im handumdrehen zu einer übermannshohen säule. das banner wird mit magnet schnell und einfach montiert. optional können sie die lampe DIMLPLP montieren und ihr motif perfekt auszuleuchten.

EN ima2go is a great pop-up tower - a real pillar of your presentation. taken out of the convenient transport bag the ima2go tower sets up in no time at all into a high column. banner mounting is quick and easy thanks to the magnetic strips. optional; you can mount the lamp DIMLPLP and illuminate your motif perfectly.

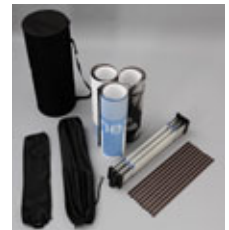
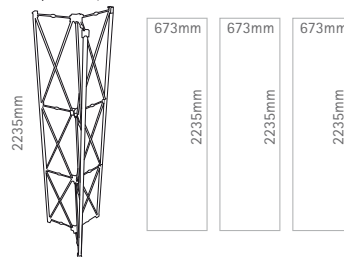

14,5

ima2go tower

n° articolo artikelnr. product nr.			
1	DIMTOW	image2go tower, 1pc	235,00€
		accessories/spare parts for ima2go tower	
2	DIMLPLP	lamp, 1pc	59,00€
3	DIMTOWACAL	magnetic roll, 1pc	32,00€
4	DIMTOWHK	hanging kits and magnets, 1set	19,00€



banner not included

x-image

MADE IN CHINA quality control by KD

IT x-image display per banner è ideale per un uso veloce e mobile, a seconda delle occasioni. l'espositore si apre e si monta in un batter d'occhio e altrettanto velocemente il telo si fissa sui 4 ganci anteriori all'estremità di ogni asta. i bracci di sostegno e quello centrale di appoggio non si incastrano tra loro perché convergono verso il meccanismo centrale. l'asta di appoggio è regolabile in altezza, così siete voi a stabilire la giusta inclinazione e visione delle vostre stampe. la borsa per il trasporto è inclusa, così x-image è sempre pronto per fiere, promozioni, stand espositivi, convegni e qualsiasi tipo di manifestazione.

DE x-image bannerdisplay für den mobilen einsatz. mit wenigen handgriffen aufgestellt, gewünschtes banner einhängen, fertig. kein verheddern, da die posterstreben am mechanismus zusammenlaufen. das standbein ist höhenverstellbar, so können sie den neigungswinkel des banners wie gewünscht einstellen. die transporttasche liefern wir gleich mit, so bringen sie ihren x-image ganz leicht zu verkaufsfaktionen, messen, produktpräsentationen sowie veranstaltungen und events aller art.

EN x-image banner display is perfect for the short-time and mobile use. set up the x-image in no time, attach the banner and you are ready. no tangling up as the banner bars are already assembled with the mechanism. the main pillar can be adjusted for height and inclination of the banner as required. we provide you with the transport bag to travel with your x-image easily to sales promotions, fairs and events of all kinds.

XIMAGE

espositore pieghevole a X per stampe digitali, aste laccate in nero, piedini di appoggio cromati, meccanismo in materiale plastico con chiusura di sicurezza, borsa per il trasporto.

faltbarer X-bannerpräsen-ter, schwarz lackiert, enden verchromt, mechanismus kunststoff mit arretierung, inkl. transporttasche.

foldable X-banner display black coated, end pieces chrome plated, mechanism with locking made of plastic, incl. transport bag.



banner not included

x-image



n° articolo | artikelnr. | product nr.

1 XIMAGE x banner display small with bag, 1pc 19,90€



1
eLgrande
39,-

banner not included



eLgrande

MADE IN CHINA quality control by KD



EL85220
facilità di montaggio: incollate o graffettate il banner alla striscia in pvc inclusa
leichte, unkomplizierte montage: banner auf das mitgelieferte pvc-profil kleben oder heften
easy and hassle-free mounting: just staple or glue to the pvc rails provided

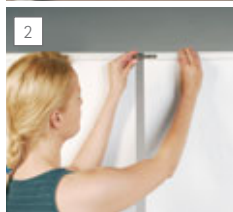

DEXT02
grazie al connettore extend è possibile unire diversi eLgrande per soluzioni modulari. basta inserire extend nella cava posteriore del profilo e avvitarlo. set composto da 2 pezzi.
mit dem extend verbindler können sie mehrere eLgrande modular für wände zusammenstellen. einfach den extend verbindler rückwärts in der schiene positionieren und festschrauben. set mit 2stück
create modular walls with the connector extend. just insert extend into the rail and fasten. set with 2 pcs

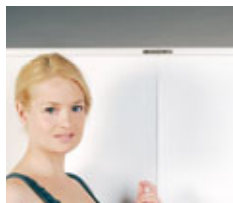

IT eLgrande, l'espositore a L per banner, è semplice da utilizzare e da trasportare. è sufficiente graffettare o incollare il banner alle strisce in pvc incluse ed inserirle nei profili di alluminio. eLgrande si monta e si smonta facilmente e i banner si possono cambiare in modo semplice e veloce. l'asta telescopica assicura piena flessibilità nello scegliere l'altezza del banner, che inoltre rimane perfettamente in tensione. la robusta borsa in tessuto per il trasporto e lo stoccaggio è inclusa nella confezione.

DE eLgrande das L-bannerdisplay ist einfach und leicht bei handling und transport. das banner auf die mitgelieferten pvc schienen tackern oder kleben und in die zwei silver eloxierten aluminiumprofile einschieben. eLgrande ist schnell auf- und wieder abgebaut, banner lassen sich leicht und schnell austauschen. mit der teleskopstange sind sie hinsichtlich der bannerlänge flexibel und das banner ist optimal gespannt. die stabile stofftasche für transport und lagerung liefern wir gleich mit.

EN eLgrande the L-banner display is convenient to handle and easy to carry. just staple or glue the banner to the pvc rails provided and insert them into the silver anodized aluminium extrusions. eLgrande is set up in no time at all and quickly stowed away after use. banners are exchanged easily. the telescopic bar allows flexibility of banner length and stretches the banner tight. the solid shoulder bag for transport and storage is included.



eLgrande

n° articolo | artikelnr. | product nr.

	structure	
1	EL85220	L-banner display with bag, 1pc 39,00€
2	DEXT02	connector extend, 2pcs 5,00€



banner not included

eleg

MADE IN CHINA quality control by KD

digii

IT eleg presenta ed espone in modo elegante le vostre stampe digitali, grazie all'asta telescopica con cui regolare l'altezza. quando l'espositore è smontato il banner e l'asta telescopica si ripongono nella base inferiore di sostegno. eleg è pronto per l'utilizzo in un batter d'occhio e si differenzia dagli espositori simili che si trovano in commercio grazie alla sua flessibilità: basta infatti infilare il banner nella base inferiore, inserirlo nel profilo superiore, tensionarlo e il gioco è fatto. la base di appoggio e l'asta telescopica sono in alluminio anodizzato. una robusta sacca per il trasporto è inclusa nella confezione.

DE eleg präsentiert ihre digitaldrucke dank des stufenlos verstellbaren teleskopstativs mit variabler länge. ihr banner und der teleskopauszug finden im standfuss platz. mit wenigen handgriffen aufgestellt, können sie bei eleg, im gegensatz zu anderen rollbannern, die banner jederzeit ganz unkompliziert wechseln: banner einfach einschieben, einhängen, spannen, fertig. standfuss und auszug sind aus eloxiertem aluminium. für den transport liefern wir ihnen die stabile tragetasche gleich mit.

EN eleg is the elegant display for your digital prints and thanks to its continuously adjustable telescopic bar you can use it for banners with variable lengths. during transport your digital print and the telescopic bar are stored inside the base. hassle-free mounting, unlike other rollbanners, changing the banner is effortless: just insert the banner in base and upper rail, then put up the telescopic bar. base and telescopic bar are made of silver anodized aluminium. the transport bag is included.



eleg



ELEG 95

montaggio semplice e non complicato: agganciare il banner sul profilo pvc incluso
 leichte, unkomplizierte montage: banner auf das mitgelieferte pvc-profil heften
 easy and hassle-free mounting: tack the banner on the pvc-rail provided

inserire il banner nei profili d'alluminio
 banner in die aluminium profile schieben.
 insert banner into the aluminium extrusions

il piedino d'appoggio, in cui inserire l'asta telescopica, è pieghevole
 der halter für teleskopauszug wird einfach ausgeklappt
 holder for telescopic bar is folded out easily

design intelligente: la base di appoggio funge anche da contenitore per asta telescopica e banner stampato.
 cleveres design: im standfuss werden banner und teleskopstange sicher verstaut.

smart design: the banner and the telescopic bar get stowed away safely in the base.



n° articolo | artikelnr. | product nr.

1 **ELEG 95** banner display with bag, 1pc **49,00€**



roll

MADE IN CHINA quality control by KD 



ROLL850

roll up espositore per banner in alluminio anodizzato, pezzi di plastica in color grigio chiaro, con asta telescopica, sacca per il trasporto inclusa

roll up display für banner, eloxiertes aluminium, lichtgraue kunststoffteile, teleskopstange, inkl. transporttasche

roll up display for banner, silver anodized aluminium, light grey plastic parts, telescopic bar, transport bag incl.



montaggio del banner con biadesivo; tirare il banner e tensionarlo regolando l'asta telescopica

montage des banners mit doppelkleber, herausziehen und mit teleskopstange spannen

mount the banner with double sided adhesive tape, pull out the banner and tighten with the telescopic bar



IT il classico roll up con riavvolgimento automatico del banner nella base è facile da montare e smontare. l'asta telescopica vi permette di regolare l'altezza del display a piacere. l'aspetto accattivante e l'alta qualità dei materiali utilizzati caratterizzano roll. ideale soprattutto per eventi di lunga durata, il banner si incolla alla base con del biadesivo. la sacca per il trasporto e lo stoccaggio dell'espositore è inclusa nella confezione.

DE das klassische roll up display mit federmechanismus für selbsteinzug des banners in der basis. durch den einzug schnell auf- und abgebaut. die teleskopstange erlaubt variable bannerlängen. ansprechende optik und hochwertige materialien zeichnen roll aus. bannermontage mit doppelkleber und damit gut für langfristige kampagnen geeignet. mit dem display erhalten sie eine robuste tasche für mobilen einsatz und aufbewahrung.

EN the classic roll up display with spring mechanism for automatic recoil into the base. quickly set up. the telescopic bars allows flexibility with banner height. stylish looks and high-grade material distinguish the roll display. the mounting of the banner is effected with double sided adhesive tape. best employed for long-term campaigns. together with the display we provide you with a robust bag for transport and storage.

roll



n° articolo | artikelnr. | product nr.

1 **ROLL850** roll up banner display with bag, 1pc **65,00€**



banner not included

show zip

MADE IN EU design by KD

digii

IT it's show time! portacataloghi composto da 3 tasche in policarbonato antiurto e resistenti ai raggi UV stampate ad iniezione che diventa anche un eccezionale porta banner. l'asta telescopica sulla quale agganciare i profili bannerblock si infila nel foro nella base dell'espositore. l'asta è regolabile in altezza da 1,3m a 2,4m. con lo show zip forniamo già un bannerblock di 700mm di larghezza. per altre misure del banner scegliete i profili più adatti dalla nostra gamma bannerblock. basta inserire il gancio nella fessura del profilo, infilare il banner e chiudere bannerblock. ideale per ogni occasione, showzip è anche facilmente personalizzabile, grazie alla tasca pixquick, sul pannello frontale, dove inserire i propri messaggi pubblicitari.

DE so stellen sie allen die show: 3 prospektaschen aus uv-beständigem und schlagfestem polycarbonat-spritzguss entfalten sich im nu zum printmaterial präsentier. in die basis stecken sie den silber eloxierten teleskophalter für die bannerblock profile. die teleskopstange ist von 1,3m bis 2,4m höhe regulierbar. zusätzlich liefern wir ein klemmprofil bannerblock mit 700mm. für andere bannerbreiten stehen ihnen in unserem bannerblock angebot weitere länge zur verfügung. halter für die profile einfach aufschrauben, banner in den profilen einklemmen und einhängen. passend zum event lässt sich mit pixquick am frontpaneel des showzip schnell und einfach mit einem eigenen druck zusätzlich personalisieren.

EN it's show time. 3 brochure pockets made of uv- and shock-resistant polycarbonate die-cast unfold easily to a brochure rack. mount the telescopic bar to the base and the bannerblock support on the bar. the bar is adjustable from 1,3m up to 2,4m. we provide bannerblock extrusion for 700mm banner width. for other banner widths you can choose the matching item out of our bannerblock assortment. clamp in your banner and hook it on the bar. with pixquick on the front panel you can customize your showzip easily with your own prints.

personalizzazione semplice e veloce:
stampare la grafica ed inserirla nel pixquick

personalisierung einfach und schnell:
grafik ausdrucken, einlegen, fertig!

quick and easy customizing:
print your graphics, insert in pixquick, ready!



SHOW3AA

3 tasche A4 in policarbonato antiurto, 1 tasca A4 pixquick per personalizzare l'espositore, base in mdf laccata color argento satinato, parti laterali e barra telescopica per fissaggio banner in alluminio anodizzato, bannerblock 700mm

3 prospektaschen A4 aus schlagfestem polycarbonat, 1 postertasche A4 pixquick für personalisierung, basis silbermattes mdf, seitenstreben und teleskopstange für bannerbefestigung silber eloxiertes aluminium, bannerblock 700mm

3 A4 brochure pockets shock-resistant polycarbonate, 1 poster pocket A4 pixquick for customizing, silver varnished mdf base, side parts and telescopic bar for banner mounting made of silver anodized aluminium, bannerblock 700mm

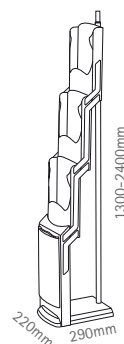

showzip



n° articolo | artikelnr. | product nr.

1 SHOWBB700

set showzip incl. bannerblock 700mm, 1pc

251,00€

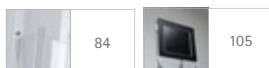

combinations



kombi soistes

MADE IN EU design by KD



SOK04A4
 profili in alluminio anodizzato color argento, connettori in metallo stampato color argento, ripiani stampati formato A4
 silber eloxierte aluminium profile, verbinder aus versilbertem metalledruckguss, ablagen A4 kunststoffspritzguss
 silver anodised aluminium profiles, connectors made of silver-plated die-cast metal, trays A4 made of die-cast synthetic material.



inclinazione del ripiano regolabile in 4 diverse posizioni
 ablagen-neigung vierfach regelbar
 4 different tray inclinations possible

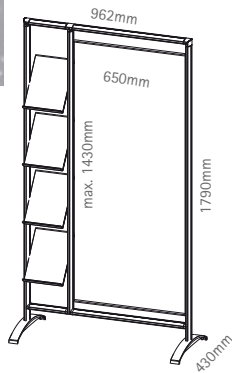
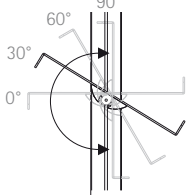

1
 kombi soistes
299,-

banner not included

IT con kombi in un unico elemento avrete la possibilità di presentare cataloghi e stampe digitali. i quattro ripiani di presentazione possono essere inclinati fino alla posizione orizzontale e offrono tanto spazio per il vostro materiale pubblicitario in formato A4. infilate le barre di sostegno nell' asola del banner precedentemente approntata e il gioco è fatto. le barre inoltre possono essere regolate in altezza per consentire diverse possibili lunghezze del banner e allo stesso tempo per garantirne la migliore tensione

DE mit kombi verbinden sie katalog- und digitaldruckpräsentation ganz perfekt. die vier ablagen sind vierfach neigbar und bieten viel platz für printmaterial in A4. für die befestigung des drucks, schieben sie die haltestangen durch den bannersaum. die höhe der stangen ist stufenlos einstellbar, so wird ihr banner optimal gespannt und sie sind in der bannerlänge flexibel.

EN with kombi you merge perfectly the presentation of brochures and print perfectly, the four trays can be inclined horizontally and offer lots of space for your information material in A4. to mount the banner just push the bars through the seam of the banner. the height of the bars can be infinitely adjusted in height. thus your banner is kept perfectly taut and the banner length is flexible.

kombi soistes

n° articolo | artikelnr. | product nr.

1 **SOK04A4**

kombi soistes, 1pc **299,00€**



1
print soistes
250,-

banner not included



print soistes

MADE IN EU design by KD

digi

SOPR1900650
 profili in alluminio anodizzato color argento, base con protezione in ABS colore grigio, inserto decorativo in alluminio color argento
 silber eloxierte aluminiumprofile, basis mit ABS trittschutzring grau, dekorinlay aluminium silber eloxiert
 silver anodized aluminium profiles, grey ABS-step-on protection ring with silver anodised aluminium decorative inlay



il sistema laterale di fissaggio a molla tensiona perfettamente i vostri banner.
 gefederte befestigung, faltenlose spannung für ihr banner
 spring loaded supports tenses your banner without creases

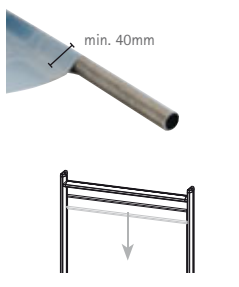
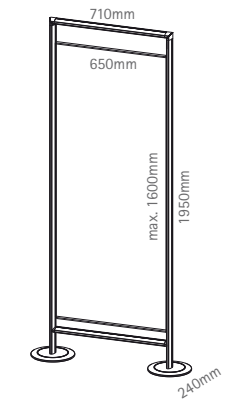

IT print soistes è il vostro espositore per stampe digitali. il fissaggio del banner è regolabile in altezza e permette l'utilizzo di stampe di varie lunghezze. il nostro consiglio: utilizzate un biadesivo con velcro per il fissaggio del banner. sfruttate il retro per renderlo bifacciale. profili in alluminio anodizzato color argento e basi con rivestimento esterno di protezione in abs.

DE print soistes - ihr digitaldruckpräseneter. die stufenlos höhenverstellbare bannerbefestigung erlaubt flexible bannerlängen. unser tip: verwenden sie für den saum klebeband mit klettverschluss. nutzen sie auch die rückseite mit druck für ihre präsentation. silber eloxierte aluminium profile und basen mit abs-trittschutz.

EN print soistes your digital print display. the freely adjustable banner supports allows for banner length flexibility. our tip: use adhesive tape with velcro for the seams and print also on the rear of your banner for double side presentations. silver anodised aluminium extrusions and bases with step-on protection made of abs.

- SINGLE
- DOUBLE
- ~~TELESCOPIC~~
- ~~RETRACTABLE~~
- ~~ELECTRONIC~~
- ~~EXTENTION~~
- ~~OUTDOOR~~
-

print soistes
 n° articolo | artikelnr. | product nr.
 1 **SOPR1900650** print soistes, 1pc **250,00€**



digiplug



DPLU8TR
 connettore ad 8 vie, PS trasparente, con filetto M5, per interni
 8-wege verbinder, transparentes PS, mit M5 gewinde, für innenbereich
 8-way connector, transparent PS, with M5 thread, for indoor use



DPLU5TR
 connettore a 5 vie, PS trasparente, con filetto M5mm per interni
 5-wege verbinder, transparentes PS, mit M5 gewinde, für innenbereich
 5-way connector, transparent PS, with M5 thread, for indoor use

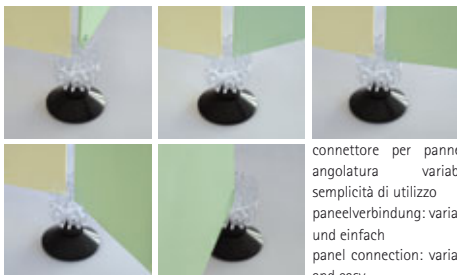

connettore per pannelli: angolarità variabile, semplicità di utilizzo
 paneelverbinding: variabel und einfach
 panel connection: variable and easy

IT leggera, facile da usare, veloce da installare: ecco digiplug, il connettore ad 8 vie per pannelli con spessore di 4 mm. digiplug è particolarmente consigliato con pannelli leggeri, di piccole dimensioni e quadrati, perché il connettore si monta sugli angoli, non in mezzo. digiplug da un lato è filettato, per consentirne l'utilizzo con tutta una serie di accessori. vi offriamo digiplug come set completo fornito in un a pratica valigetta per il trasporto o a singoli componenti.

DE schnell leicht und einfach: das ist digiplug 8-wege verbinder für 4mm starke paneele. besonders empfiehlt sich digiplug mit kleinformatigen, quadratischen leichtstoffplatten, da digiplug an den ecken, nicht mittig, eingesetzt wird. jeder digiplug hat an einer seite ein gewinde für die befestigung von zubehör. wir bieten ihnen digiplug als komplettsset im praktischen transportkoffer oder als einzelkomponente an.

EN quick, light and easy: this is digiplug, the 8-way connector for 4mm panels. especially recommended is digiplug with small sized, squared lightweight panels as the connector is used at the corners, not in the middle. every digiplug comes with a thread on one side for mounting the accessories. we offer digiplug as a complete set with handy transport case or as single components.

digiplug



n° articolo | artikelnr. | product nr.

1	DPLU8TR	digiplug full, transparent, 1pc	1,00€
2	DPLU5TR	digiplug half, transparent, 1pc	0,90€
3	DPLUREG	digiplug regulator, 1pc	1,90€
4	DPLUAVEN	digiplug suction cup, 1pc	0,90€
5	DPLULMP	digiplug lamp, 1pc	48,00€
6	DPLUAS	digi plug antislip pad 0,8mm, 20pcs	6,00€
7	DPLUFS	digiplug full set, 1pc	180,00€

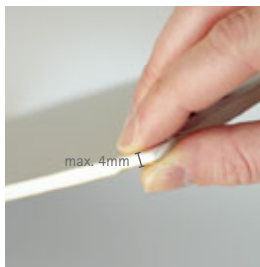
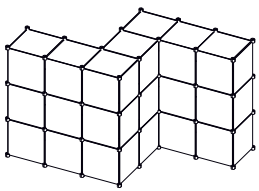
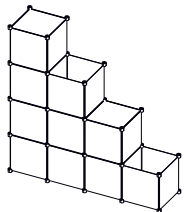
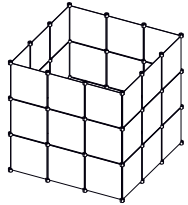
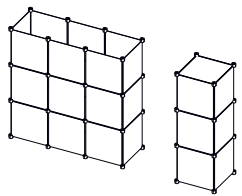

particolarmente indicato per pannelli leggeri flessibili e non troppo rigidi o per cartone di 5 mm di spessore, ma che si possano ridurre a 4 mm durante l'inserimento in digiplug.

besonders geeignet für flexible leichtstoffplatten oder karton mit 5mm, die sich auf 4mm bei einschub reduzieren.

especially recommended for flexible lightweight panels or cardboards with 5mm that reduce to 4mm when inserted



accessori: le lampade vengono fissate sui pannelli, i piedini e le ventose vengono avvitati sul filetto.

zubehör: lampen werden aufgesteckt, standfüsse und haftsauer werden am gewinde eingeschraubt

accessories: lamps are simply plugged on top, feet and suction cups are screwed into the thread



DPLUREG
i piedini sono di materiale plastico nero
standfuss aus schwarzem kunststoff
foot made of black synthetic



DPLUAVEN
le ventose, filettate, sono ideali per il fissaggio su superfici lisce
haftsauer mit gewinde für befestigung auf glatten oberflächen
suction cup with thread for mounting on smooth surfaces



DPLULMP
lampade alogene a 35 W per il completamento della composizione
35W halogenstrahler zum aufstecken
35W halogen lamp to plug in



DPLUAS
biadesivo per pannelli da 3mm
doppelkleber für 3mm paneele
double adhesive tape for 3mm panels



DPLUFS
set completo composto da 2 lampade alogene, 8 piedini, 8 ventose, 12 digiplug da 180°, 28 digiplug interi da 360°, valigetta per il trasporto.
komplettset mit 2 halogenleuchten, 8 standfüssen, 8 haftsauer, 12 half und 28 full digiplug, transportkoffer
complete set with 2 halogen lamps, 8 feet, 8 suction cups, 12 half and 28 full digiplugs, transport case





connector

MADE IN TAIWAN quality control by KD 



IT sistema modulare ad incastro per vetrine. realizzate la vostra personalissima vetrina con pannelli da 5mm e fissaggi angolari "connector" in policarbonato color vetro. utilizzate gli esempi proposti per individuare l' elemento idoneo al vostro allestimento. i "connector" sono venduti singolarmente, ciò vi consente di ordinare solo quello che vi serve realmente. ideale per negozi, showroom, musei, vetrine e anche per l'arredamento di casa.

DE schlagfeste eckverbinder aus glasgrünem polycarbonat für cuben nach dem baukasten-system. gestalten sie ihre persönliche vitrine mit connector eckhaltern und 5mm-paneeeln. die beispieldisken helfen Ihnen bei der richtigen auswahl der entsprechenden eckverbinder. eine tolle sache für shop, showroom, museum, schaufenster und homebereich.

EN shock-resistant panel-connector made of glassgreen polycarbonate for modular cube systems. create your personal show case with 5mm-panels and connectors. the drawings with examples help you choosing the right parts. it's a peach for shop, showrooms, museums, shop windows and at home as well.

connector

n° articolo artikelnr. product nr.			
A	FCONA	1 pc	0,90€
B	FCONB	1 pc	0,99€
C	FCONC	1 pc	1,10€
D	FCOND	1 pc	1,30€
E	FCONE	1 pc	1,65€
F	FCONF	1 pc	2,20€
G	FCONG	1 pc	2,90€
H	FCON330PL	shelf, transparent acrylic, 330x330x5mm, 1 pc	15,50€

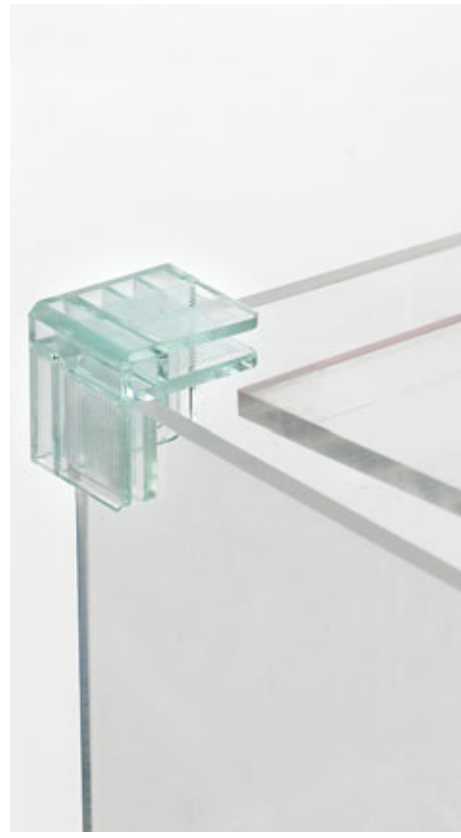
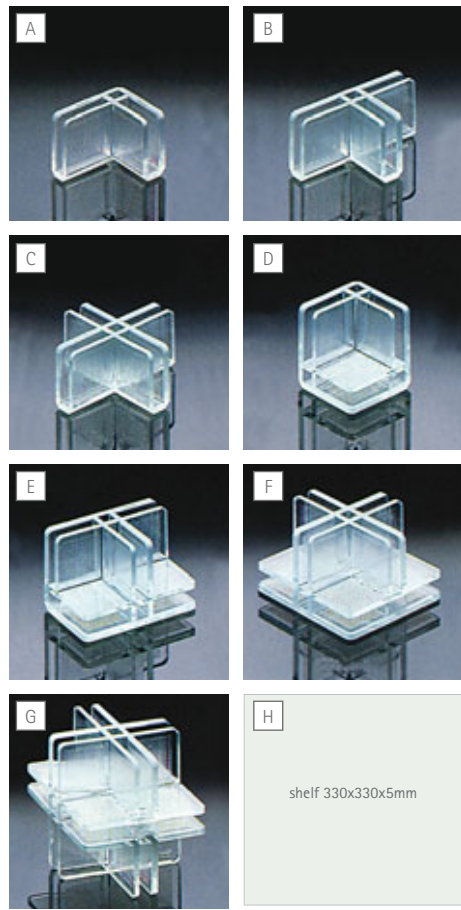
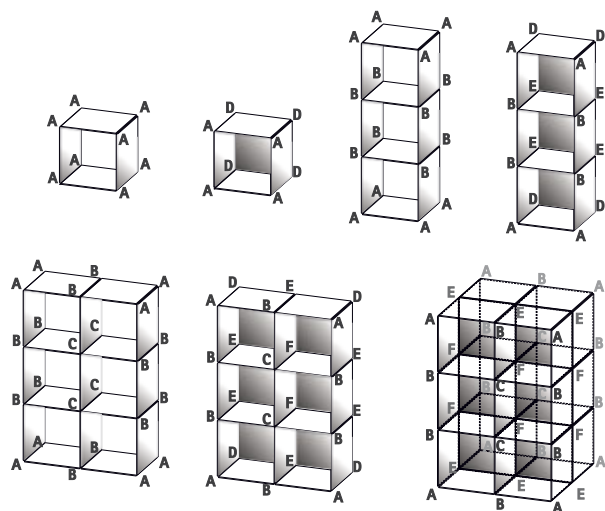

1 IX2B60AR
 60° connettore: zamac color argento satinato, vite acciaio inox
 60° verbinder: versilberter metall-druckguss, schraube edelstahl
 60° connector: silver-plated metal die-cast, stainless steel screw

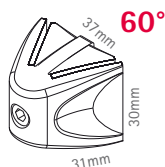

2 IX2B90AR
 90° connettore: zamac color argento satinato, vite acciaio inox
 90° verbinder: versilberter metall-druckguss, schraube edelstahl
 90° connector: silver-plated metal die-cast, stainless steel screw

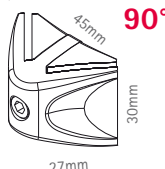

3 IX2B120AR
 135° connettore: zamac color argento satinato, vite acciaio inox
 135° verbinder: versilberter metall-druckguss, schraube edelstahl
 135° connector: silver-plated metal die-cast, stainless steel screw

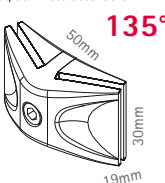

4 IX2B180AR
 180° connettore: zamac color argento satinato, vite acciaio inox
 180° verbinder: versilberter metall-druckguss, schraube edelstahl
 180° connector: silver-plated metal die-cast, stainless steel screw

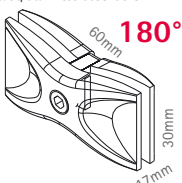

5 IX2BSWAR
 in zamac color argento per fissare pannelli a "sandwich".
 versilberter metall-druckguss für die sicherung von sandwich systemen.
 silver-plated metal die-cast for locking sandwich systems.

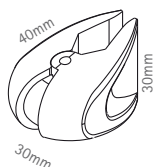

ix bond

MADE IN EU design by KD

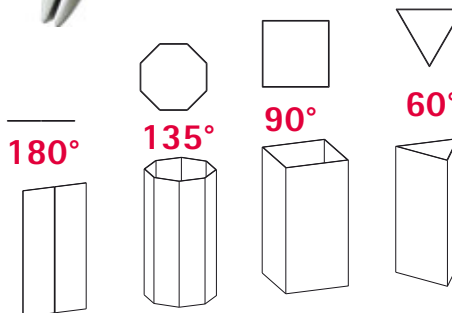
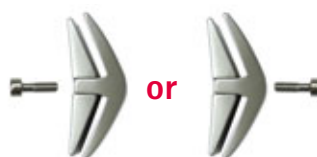
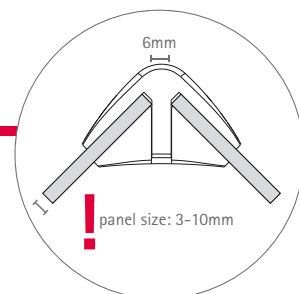

IT ixbond può connettere pannelli da 3 a 10mm con sicurezza e senza il rischio di torsioni. discreto e funzionale una volta uniti, i pannelli risulteranno a soli 6mm di distanza. la vite di chiusura è facilmente raggiungibile dal lato esterno e dal lato interno garantendo così la migliore comodità di esercizio - pratico, specialmente per strutture 3D o vicino alle pareti. ergonomici e decorativi "snodi" per montare in convenienza. cacciaviti a parte

DE ixbond verbindet paneel von 3-10mm stufenlos sicher und verwindungsstabil. die sichtfuge bleibt dabei immer dezent mit 6mm. die schraube kann beidseitig (innen wie aussen) eingesetzt werden - praktisch, wenn sie räumliche konstruktionen umsetzen oder nahe an wänden bauen. ergonomische und ästhetische griffmulden erleichtern die montage. gewünschte anzahl inbus-schlüssel bitte extra bestellen.

EN ixbond connects 3-10mm panels infinitely and free of torsion. the face joint remains at a discrete 6mm gap. the screw can be mounted from both sides. convenient if you create structures in 3-D or close to walls. ergonomic and decorative recessed grips make mounting easy. order the required keys separately.



panel not included

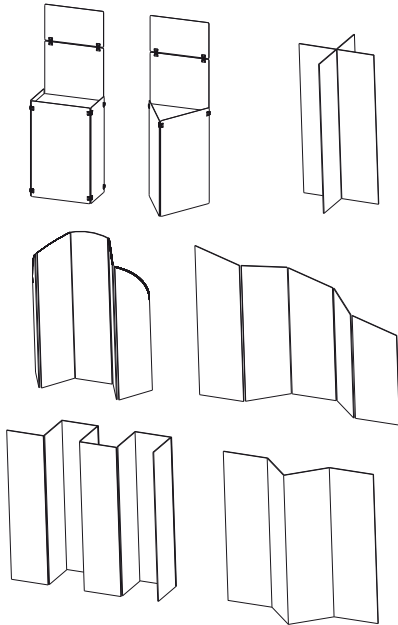

Zamac

SOKEY 6
 chiave esagonale 4mm
 inbusschlüssel 4mm
 key 4mm hex ballpoint L-handle

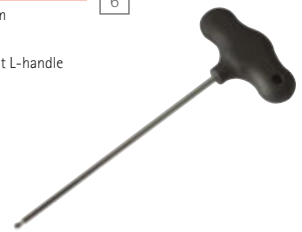

ATPXB 7
 ix bond feltrino (spessore 1mm) per il montaggio di materiale delicato o vetro. spessore pannello: 2mm-8mm.
 ix bond buffer (1mm thick) für die befestigung von empfindlichen materialien oder glas. paneelstärke mit buffer: 2mm-8mm.
 ix bond buffer (1 mm thick) for the mounting of sensitive materials or glass. panel thickness with buffer: 2mm-8mm.

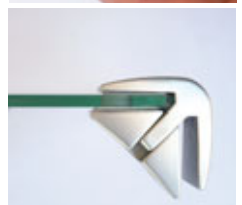
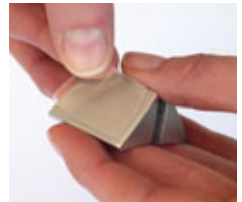

ix bond

n° articolo artikelnr. product nr.			
1	IX2B60AR	60° connector, 1pc	6,80€
2	IX2B90AR	90° connector, 1pc	6,80€
3	IX2B120AR	135° connector, 1pc	6,80€
4	IX2B180AR	180° connector, 1pc	5,60€
5	IX2BSWAR	180° connector, 1pc	7,80€
6	SOKEY4	ixbond sandwich connector, 1pc	2,50€
7	ATPXB	ix bond buffer, box/20pcs	7,90€



panel not included

digipressto

MADE IN EU design by KD



PT235	235mm	profilo in alluminio anodizzato con protezione anti-scivolo, vite a testa zigrinata
PT300	300mm	
PT400	400mm	klemmprofil aus eloxiertem aluminium, mit anti-rutsch schutz und rändelschraube
PT500	500mm	clamping profile made of anodized aluminium with anti-slip protection and knurled head screw



PTAKSZ
tappi laterali abs nero, set con 4 pz
seitenabdeckkappen abs schwarz,
set mit 4 stück
lateral cover caps abs black, set with
4 pcs

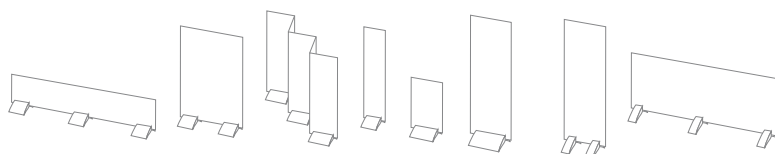

IT digipressto è straordinario: grazie a lui i vostri pannelli potranno diventare indicatori di direzione, banner pubblicitari, divisori di spazio o elementi decorativi per interni ed esterni. utilizzate a piacere la base in alluminio con pannelli di 30 mm: grazie alla sua speciale conformazione, pannelli di qualsiasi materiale rimangono stabili e dritti sulla base. digipressto si apre e si chiude grazie ad una vite a testa zigrinata che tiene uniti i 2 profili. i feltrini compresi nella confezione proteggono il pannello e rendono la base anti-scivolo e più stabile. nella versione in alluminio anodizzato color argento digipressto è disponibile già montato nei formati più comuni. il programma di accessori comprende tappi laterali in colore nero e 2 versioni laccate in nero rispettivamente di 100mm e 200mm (con tappi laterali neri).

DE eine tolle sache: mit ihrem panel wird digipressto zum hinweisschild, werbebanner, raumteiler oder dekorativem element im innen- und aussenbereich. kombinieren sie das aluminiumprofil mit paneelen der stärke von 30mm. unterschiedlichste materialien werden gleichmässig eingespannt. geöffnet und geschlossen wird digipressto mittels rändelschraube. integrierte gummilitzen schützen ihr panel und geben rutschfesten stand. in silber eloxierter ausführung sind die gängigsten längen vormontiert. im zubehör programm finden sie schwarze seitenabdeckkappen. ausserdem im programm: 100mm bzw. 200mm mit schwarzer pulverbeschichtung und abdeckkappen.

EN digipressto is really great: together with your panel digipressto becomes a signpost, an advertising banner, a partition wall or a decorative element in interior and exterior areas. combine the anodized aluminium profile with panel from 30mm. the special construction gives digipressto maximum flexibility: materials are shut in safely by digipressto. open and close the profile easily with the knurled head screw. integrated rubber laces protect your panel and act as anti-slip pads as well. the most standard lengths come already mounted. black side caps can be ordered as an accessory. furthermore we provide you with 100mm and 200mm lengths black powder coated and with side caps.



2 digipressto silver 300mm

95,50

panel not included

PT100SZ
 digipressto 100mm laccato nero
 con tappi laterali
 digipressto 100mm schwarz
 beschichtet mit seitenkappen
 schwarz
 digipressto 100mm black coated
 with black side caps



PT200SZ
 digipressto 200mm laccato nero
 con tappi laterali
 digipressto 200mm schwarz
 beschichtet mit seitenkappen
 schwarz
 digipressto 200mm black coated
 with black side caps

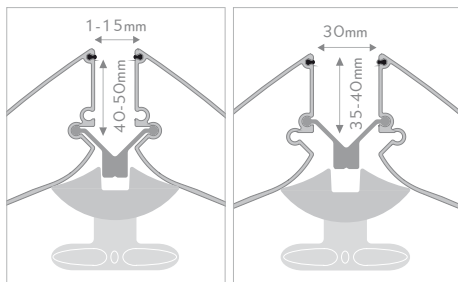

l'altezza massima del pannello varia a seconda del materiale utilizzato e del suo spessore. ogni applicazione deve essere verificata prima della installazione.

maximale panel-höhe und -breite sind vom verwendeten plattenmaterial abhängig. jede anwendung ist daher individuell auf eignung zu prüfen.

maximum panel height and width depend on the used material. every application has to be approved individually if appropriate.

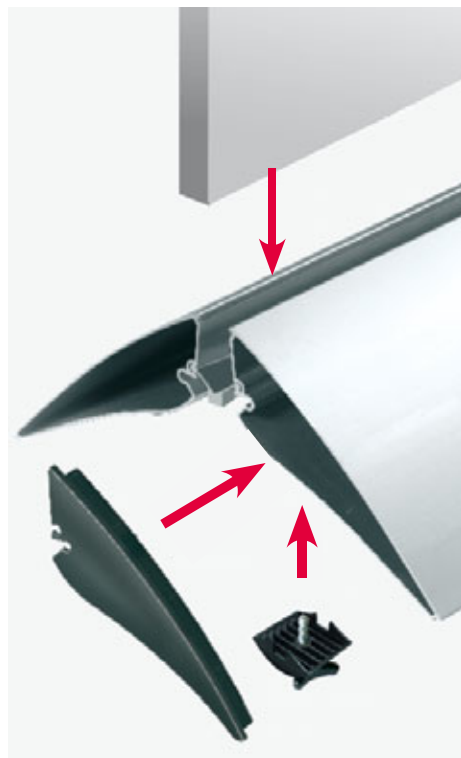

digipressto



n° articolo | artikelnr. | product nr.

1	PT235	digipressto silver 235mm, 1pc	67,50€
2	PT300	digipressto silver 300mm, 1pc	95,50€
3	PT400	digipressto silver 400mm, 1pc	111,00€
4	PT500	digipressto silver 500mm, 1pc	124,00€
5	PT100SZ	digipressto black 100mm, 1pc	58,00€
6	PT200SZ	digipressto black 200mm, 1pc	85,00€
7	PTAKSZ	cover caps black, 4 pcs	10,50€

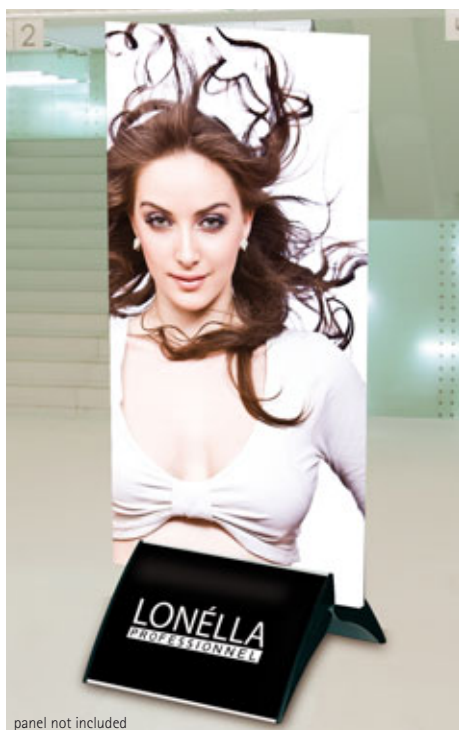

panel not included

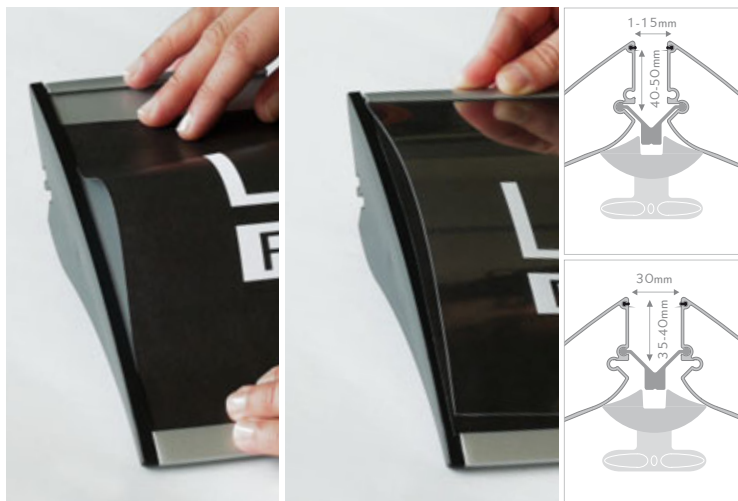

mypressto

MADE IN EU design by KD

MYPTA4	297x210mm
MYPT400	400x210mm
MYPT500	500x210mm

in alluminio anodizzato color argento satinato, tappi laterali colore nero, foglio protettivo trasparente

silber eloxiertes aluminium, schwarze abdeckkappen, transparente cover-folie

silver anodized aluminium, black caps, transparent cover



IT mypressto vi offre tutti i vantaggi del sistema digipressto ed in più la possibilità esclusiva di personalizzare la superficie con una grafica adatta all' evento, il corporate aziendale o perfino per renderlo adatto al tipo di arredo circostante. basta la stampa con o senza il foglio protettivo. non solo a immagini, quindi, o marchi aziendali, ma design a colori o per riprendere ornamenti alle pareti o sul pavimento. i tappi laterali in colore nero rifiniscono e completano il vostro my pressto.

DE mypressto bietet neben den bewährten digipressto-klemmpfprofil vorteilen auch noch die einzigartige möglichkeit der persönlichen gestaltung passend zum event, zum corporate oder sogar zur inneneinrichtung. einfach den passenden druck mit oder ohne coverfolie einschieben. denken sie dabei nicht nur an bilder oder firmenlogos: farbige gestaltung oder boden- bzw. wanddekore aufzunehmen hat immer eine ganz besondere wirkung. die abdeckkappen in elegantem schwarz runden das gesamtbild ab.

EN besides all the approved advantages of the digipressto system, mypressto can be customized to match your event, the company corporate or even the interior decoration. simply insert the matching print with or without cover. think different: not only images or logos - colourful designs or copying the floor or wall decoration has a very special effect. elegant black caps complete the overall look.



mypressto

n° articolo | artikelnr. | product nr.

		structure	
1	MYPTA4	mypressto, A4, 1pc	102,00€
2	MYPT400	mypressto, 210x400mm, 1pc	119,00€
3	MYPT500	mypressto, 210x500mm, 1pc	129,00€
		accessory	
4	IX2BSWAR	ixbond sandwich connector, 1pc	7,80€
5	SOKEY4	t-handle hex key, 1pc	2,50€



2

myspresso 210x400mm

119,-

panel not included

4

IX2BSWAR

in zamac color argento per fissare pannelli a "sandwich". cacciaviti a parte
 versilberter metalldruckguss für die sicherung von sandwich systemen. inbus-schlüssel bitte extra bestellen.
 silver-plated metal die-cast for locking sandwich systems. order the required keys separately.



5

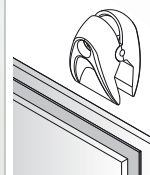

con foglio protettivo da 1mm per materiale fino ad 1mm di spessore
 mit cover-folie (1mm) können sie max. 1mm starkes material verwenden
 with cover (1mm) you can use max. 1mm thick material

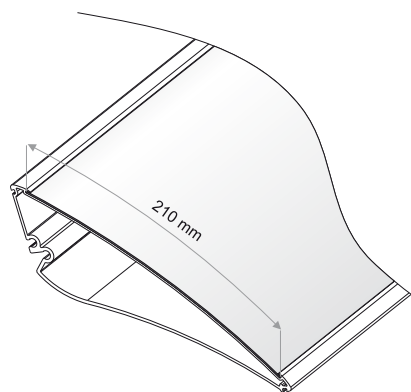
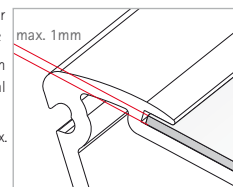

personalizzazione semplice ed immediata direttamente con il tuo pc e stampante!

beliebiges motiv am pc gestalten, ausdrucken, fertig!

design your image with pc, print and here you go!



2
pylo 1905x600mm
535,-

pylo

MADE IN EU design by KD

other possible combinations

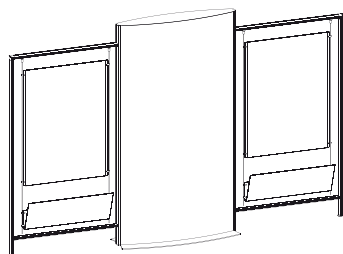

- SOPY1900400 1
- SOPY1900600 2
- SOPY1900800 3

alluminio anodizzato color argento, base verniciata a polvere color argento

silber eloxiertes aluminium, silber pulverbeschichtete metallbasis

silver anodized aluminium, powder coated metal base

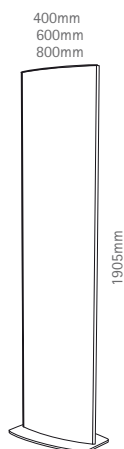

1
pylo 1905x400mm
410,-

print not included

IT totem pylo: base metallica verniciata a polvere color argento e profili in alluminio anodizzato argento; i pannelli portainformazioni offrono una comoda e versatile superficie per stampe dirette, scrivibili o a plotter; il pylo è disponibile in tre differenti larghezze, ideale come sistema autoportante oppure abbinato agli elementi modulari del sistema soistes. i fori nella base permettono, se necessario, un sicuro ancoraggio al suolo.

DE totem pylo: silber pulverlackbeschichtete metallbasis, silber eloxierte aluminium-profile und -paneel zum bedrucken, bekleben und beschriften. erhältlich in drei verschiedenen breiten. optimal als freistehendes display oder in kombination mit dem modularen einrichtungssystem soistes. mit den lochbohrungen in der basis kann pylon bei bedarf sicher im boden verankert werden.

EN totem pylo: silver powder coated metal base, silver anodized aluminium extrusions and panels for print or laminate. available in three different widths. perfect as a freestanding display as well as in combination with our modular display system soistes. thanks to the holes in the base the pylo can be safely anchored in the ground if necessary.



pylo

n° articolo | artikelnr. | product nr.

1	SOPY1900400	pylo 1905x400mm , 1pc	410,00€
2	SOPY1900600	pylo1905x600mm, 1pc	535,00€
3	SOPY1900800	pylo 1905x800mm, 1pc	630,00€



facile e rapida apertura della custodia protettiva grazie al suo razionale design
 schnelles und unkompliziertes öffnen und schliessen der cover folie dank cleverem design
 quick and easy opening and closing of the cover sheet thanks to our clever design.

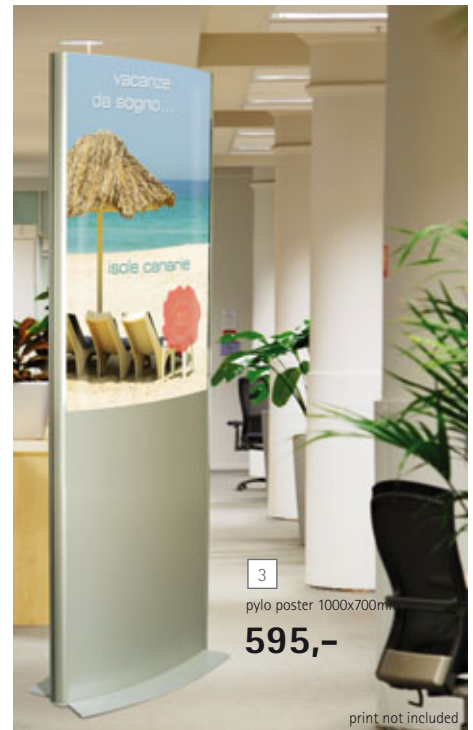

pylo poster

MADE IN EU design by KD

IT pylo poster è il totem autoportante per la presentazione di informazioni facilmente sostituibili grazie alle tasche portaposter disponibili in tre diverse misure e munite di protezione trasparente flessibile in policarbonato resistente ai raggi ultravioletti.

DE freistehendes totem pylo poster für flexible informationpräsentation: mit beidseitigen postertaschen erhältlich für drei gängige plakatgrößen. ausführung wie pylo mit flexibler coverfolie aus uv-beständigem polycarbonat.

EN freestanding totem pylo poster for flexible information presentations: with poster pockets on both sides in the most common poster sizes. design and materials like pylo plus a flexible cover sheet made of uv-resistant polycarbonate.

integrate your pylo to soistes structure....



pylo poster

n° articolo | artikelnr. | product nr.

1	SO19PP700500	pylo poster 700x500mm , 1pc	490,00€
2	SO19PPA1	pylo poster A1, 1pc	499,00€
3	SO19PP1000700	pylo poster 1000x700mm, 1pc	595,00€



- SO19PP700500
- SO19PPA1
- SO19PP1000700

profilo in alluminio anodizzato color argento, pannello in alluminio argentato con pellicola di policarbonato resistente ai raggi UV, base metallica verniciata color argento
 silber eloxiertes aluminium profil, silber aluminium verbund paneel, uv-beständige PC folie, silber lackierte metallbasis
 silver anodized aluminium extrusion, silver aluminium composite panel, uv-resistant pc cover, silver coated metal base



	poster	visible
1	700x500mm	700x474mm
2	841x594mm	841x568mm
3	1000x700mm	1000x674mm

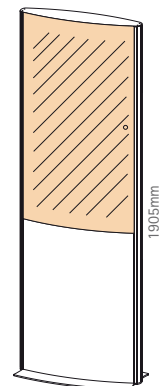



1
ipoint 1900x400
308,-

- 1 IP1900400ARW
- 2 IP1900600ARW

profili in alluminio anodizzato color argento, base metallica verniciata a polvere color argento, pannelli di alluminio composito color bianco opaco e argento, angoli in zamac color argento
silber elox-aluminium profil, basis metall silber pulverbeschichtet, alu-verbundpaneel mattweiss/silber, eckverbinder versilberter metall-druckguss
silver anodized aluminium extrusion, base silver coated metal, aluminium composite panel matt white/silver, edge connectors silver-plated die-cast metal



ipoint

MADE IN EU design by KD

IT ipoint è il pratico totem fornito completo di due pannelli in alu bond colore argento e bianco opaco per la stampa digitale, che vi permetterà di creare la vostra grafica sia sul fronte che sul retro. dopo aver effettuato la personalizzazione, incollate i pannelli direttamente ai profili con del silicone o con un'altra colla adatta per quel tipo di materiale. inoltre, a scelta si possono aggiungere ripiani, barre laterali, accessori o altri moduli ipoint dalla linea soistes. chiedeteci e noi saremo sempre a disposizione per darvi ulteriori idee ed informazioni.

DE ipoint liefern wir ihnen mit zwei doppelseitigem alu-verbundpaneel: silber und weiss matt für digitaldruck. sie können so selbst entscheiden wie sie jeweils die vorder- und auch die rückwand ihres ipoint gestalten. nach der personalisierung verkleben sie den ipoint mit silikon oder anderem geeigneten klebstoff direkt am profilrahmen. optional lassen sich ablagen, display bars oder weitere ipoint flächen ergänzen. fragen sie uns, wir beraten sie gerne.

EN ipoint comes complete with two double side aluminium composite panels: satin silver and matt white for digital printing. thus you can freely design front and rear side of your ipoint. after customizing the panels can be simply fixed with silicone or other glue to the profile frame. optionally you can add trays, display bars or further ipoint modules. just ask us, it is our pleasure to provide you with more ideas and further information.

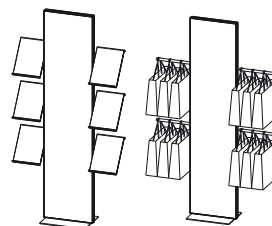

ipoint

n° articolo artikelnr. product nr.	structure	
1 IP1900400ARW	ipoint 1900x400 silber/weiss, 1pc	308,00€
2 IP1900600ARW	ipoint 1900x600 silber/weiss, 1pc	397,00€



ipoint mini

MADE IN EU design by KD

IT piccolino ma carino: ipoint mini vi offre tutti i vantaggi dell'ipoint ma in soli 200 mm di larghezza ed un'altezza ridotta.

DE klein aber fein: der ipoint mini mit allen vorteilen des ipoint, aber mit nur 200mm breite und geringerer höhe.

EN small but nice: the ipoint mini with all advantages of the ipoint, but with a lean width of only 200mm and a convenient height.

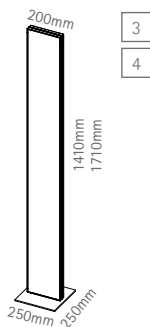

ipoint mini

n° articolo artikelnr. product nr.		structure	
3	IP1400200ARW	ipoint 1410x200 silber/weiss, 1pc	165,00€
4	IP1700200ARW	ipoint 1710x200 silber/weiss, 1pc	185,00€

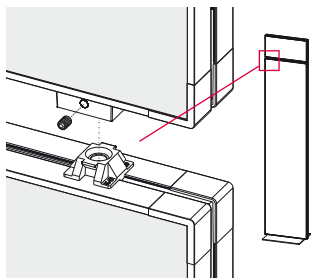

IPTCON
 connettore per strutture ipoint in zamac color argento
 verbinder für ipoint strukturen, versilberter metall druckguss
 connector for ipoint structures, silver plated die-cast metal



IT grazie ad ipoint connector il vostro espositore ipoint diventa modulare. basta inserire i dadi nei profili prima di effettuare il montaggio, in modo da poter aggiungere alla struttura tutta una serie di elementi in modo semplice e veloce.

DE modular wird ihr ipoint mit dem ipoint connector. vor der montage einfach die nutsteine einschieben und schon können mehrere elemente ganz einfach verbunden werden.

EN make your ipoint modular with the ipoint connector. just slide in the nuts before mounting and thus you can very easily connect more elements to each other.

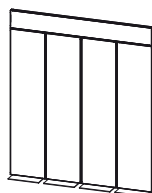
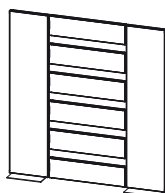

ipoint connector

MADE IN EU design by KD

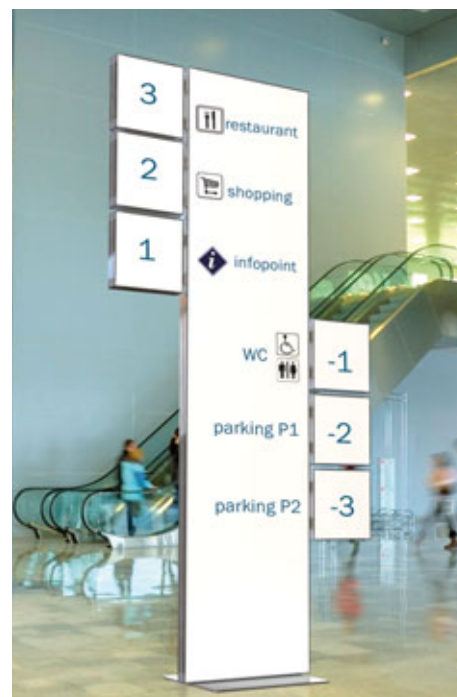

ipoint connector

n° articolo artikelnr. product nr.			
5	IPTCON	ipoint connector, set 2pcs	10,20€



1 + 2x 2
signwalk
price for this combination

88,-

print not included



signwalk

MADE IN EU design by KD

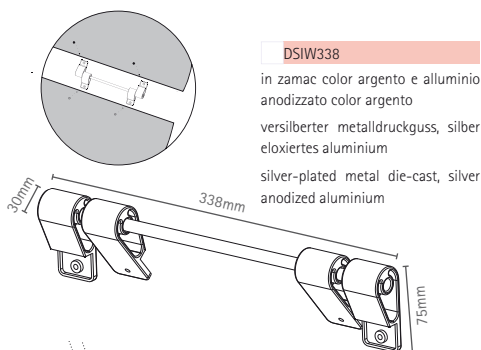

DSIW338

in zamac color argento e alluminio
anodizzato color argento
versilberter metalldruckguss, silber
eloxiertes aluminium
silver-plated metal die-cast, silver
anodized aluminium

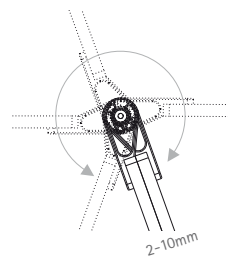

facilmente apribile e richiudibile
einfach schwenkbar zum öffnen
bzw. schliessen
rotate for simple opening or closing

DSIW700500W

pannello, forex color bianco, 10mm
paneel, forex weiss, 10mm
panel, white forex, 10mm

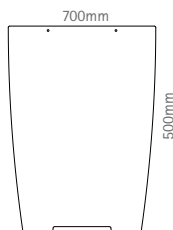

IT con signwalk siete sempre in movimento: il design intelligente consente di unire 2 pannelli di qualsiasi materiale, per comporre un elegante display per interni ed esterni. Signwalk può essere utilizzato anche per trasportare comodamente tutta la struttura. Il nostro consiglio: quando non lo utilizzate, chiudete i pannelli, in modo che i lati stampati vadano a trovarsi all'interno - per un trasporto o uno stoccaggio a prova di graffio. signwalk viene fornito singolarmente o, a richiesta, con i pannelli in forex di colore bianco.

DE mit signwalk sind sie jederzeit mobil: das clevere design verbindet 2 paneele beliebigen materials zum kundenstopper für in- und outdoor. die verbindungsstange ist zugleich praktischer tragegriff. für transport und lagerung klappen sie beide paneele auf den bedruckten seiten bündig zusammen, so bleibt das decor kratzgeschützt bei reise und lagerung. wir bieten ihnen die struktur sowie passende forex paneele in weiss.

EN with signwalk you are mobile: the clever design that turns 2 panels of any material into a display for in- and outdoor. the connector bar is a convenient carrying handle. for transport and storage just fold signwalk with the images inside and it will be protected against scratches during transport and storage. we offer you the structure and matching white forex panels as well.

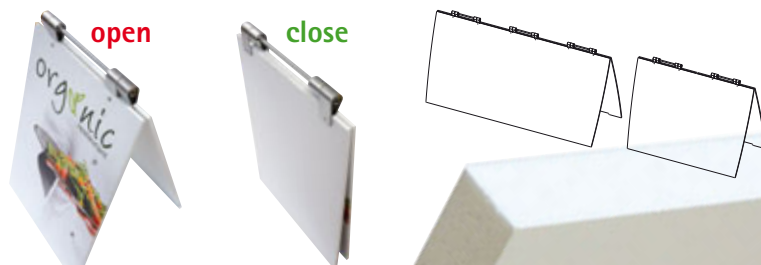

signwalk

n° articolo | artikelnr. | product nr.

1	DSIW338	signwalk, panel excl., 1pc	22,00€
2	DSIW700500W	panel white 700x500mm, 1pc	33,00€

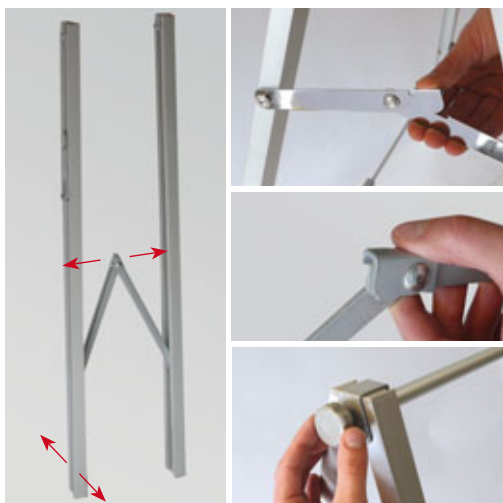

1
passboard
49,50

panel not included

passboard

MADE IN CHINA quality control by KD 

IT passboard diventa in un attimo un pratico display, basta semplicemente inserire il pannello stampato. una soluzione pratica ed economica per l'interno e l'esterno.

DE passboard entfaltet sich im nu zum praktischen präseniter, einfach paneel einschieben fertig. die ökonomische, mobile lösung für innen- wie aussenbereich.

EN passboard folds up in no time at all to a walkway display, simply insert the panel and here you go. an economic and mobile application for in- and outdoor.

DPAB1130
struttura pieghevole in alluminio anodizzato color argento
klappbare struktur aus silber eloxiertem aluminium
foldable structure made of silver anodized aluminium



inserire il pannello dal alto
paneel von oben einschieben
insert panel from the top

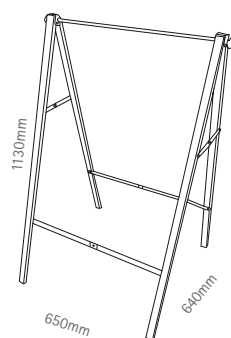

panel size 605x843x6mm
visible graphic 592x842mm

passboard

-  SINGLE
-  DOUBLE
-  TELESCOPIC
-  RETRACTABLE
-  ELECTRONIC
-  EXTENTION
-  OUTDOOR
-  2,3
-  2,8

n° articolo | artikelnr. | product nr.

1 **DPAB1130** passboard, panel excl., 1pc **49,50€**



1
outer
188,-

banner not included

y-espositore per banner in materiale plastico e alluminio, base riempibile, sacca per il trasporto inclusa
 y-display für banner, aluminium und kunststoff, befüllbare basis, inkl. transporttasche
 y-display aluminium and plastic, base refillable, transport bag incl.

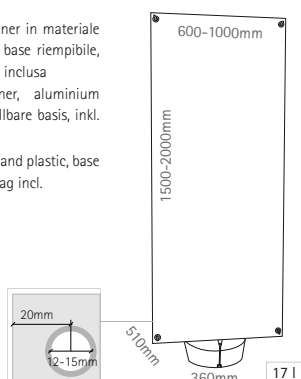

regolare la barra di fissaggio inferiore a seconda della larghezza del banner
 die untere befestigungsschiene auf die bannerbreite einstellen
 adjust the lower rail to banner width

l'asta telescopica e i bracci di sostegno laterali si inseriscono nella base
 das teleskopstativ mit den bannerstreben wird in die basis gesteckt
 the telescopic pole with banner bars is inserted into the base

outer

MADE IN SOUTH KOREA quality control by KD

IT state cercando un espositore particolarmente stabile e sicuro per le vostre stampe digitali in esterno? in questo caso vi consigliamo il nostro outer. la base in materiale plastico può essere riempita con acqua o sabbia in modo da dare stabilità all'espositore. grazie alla sua particolare struttura potete utilizzare outer per banner di lunghezza e larghezza variabili. ciò viene reso possibile dalla sua asta telescopica e dai bracci laterali flessibili. i bracci superiori sono mobili, non fissi, cosa che rende il montaggio del display estremamente facile e veloce. la struttura di outer è in materiale plastico mentre le barre sono in alluminio: outer è dunque molto leggero. dopo l'utilizzo svuotate la base e riponete struttura e base nella pratica sacca per il trasporto, inclusa nella confezione.

DE sie suchen für ihre digitaldruckpräsentation im aussenbereich ein besonders stabiles display? für diesen fall bieten wir ihnen outer. die kunststoff-basis mit wasser oder sand befüllen und schon wirft den outer so leicht nichts mehr um. dank der besonderen konstruktion können sie banner sowohl mit variablen breiten wie längen präsentieren. teleskopauszug und flexible bannerstreben machen es möglich. die oberen bannerstreben sind mit dem auszug beweglich verbunden, so dass ihr outer mit wenigen handgriffen aufgestellt ist. outer ist bis auf die aluminiumstange komplett aus kunststoff. das spart gewicht. nach dem einsatz entleeren sie einfach die basis und verstauen alle teile in der mitgelieferten praktischen tasche.

EN looking for a stable outdoor bannerdisplay? then outer is the right choice. fill the plastic base with water or sand and your outer will stand firm and secure. thanks to its special design, outer is suitable for banners with variable width and height. a telescopic pole and the flexible banner bars render this flexibility possible. setting up is easy as the banner bars are already connected to the pole. made of plastic and aluminium, outer is a lightweight. after the job just empty the base and store all parts in the transport bag provided.

outer



n° articolo | artikelnr. | product nr.

1 OUTER outer, 1pc 188,00€



panelpod

MADE IN CHINA quality control by KD

IT il display pratico per la presentazione di pannelli sia per l' interno che per l' esterno; riempito con acqua oppure con sabbia, panelpod vi garantirà una presentazione davvero stabile. la sostituzione comoda e veloce nonché il prezzo vantaggioso sono i punti forti della nostra base realizzata in materiale sintetico color nero. particolarmente adatto per pannelli da 10 mm di spessore.

DE praktisches paneeldisplay für innen- wie aussenbereich: mit sand oder wasser befüllt garantiert der panelpod standfeste präsentation. bequemer und schneller wechsel sowie ökonomischer preis sind die vorteile des schwarzen kunststoffpräsenters. empfohlen für paneele mit 10mm stärke.

EN handy panel display for in- and outdoor: filled with sand or water the panelpod guarantees you a real stable presentation. convenient and quick exchange with budget friendly price are the advantages the black synthetic display will provide you with. best with 10mm thick panels.



1

panelpod

59,-

panel not included

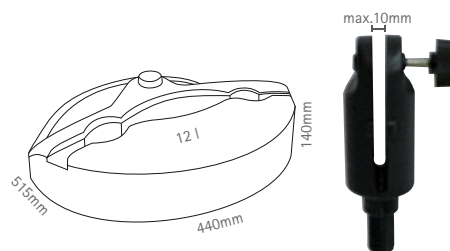

panelpod



n° articolo | artikelnr. | product nr.

1 DPP440SZ

panelpod, panel excl., 1pc

59,00€

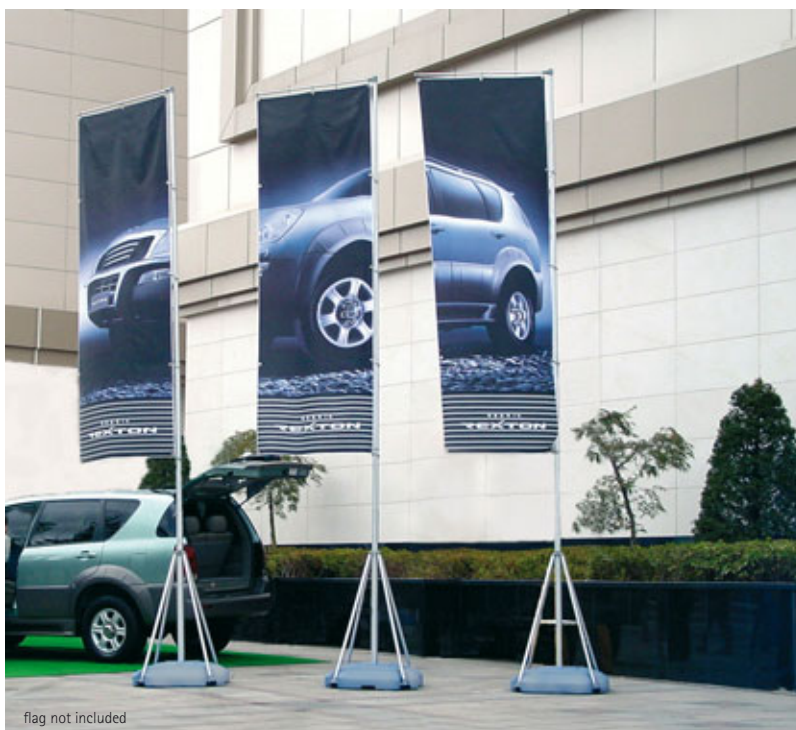

flag not included

braccio telescopico retraibile per un facile fissaggio della bandiera
 teleskopauszug eingezogen zur mühelosen befestigung der fahne
 telescopic flagstaff for comfortable flag mounting

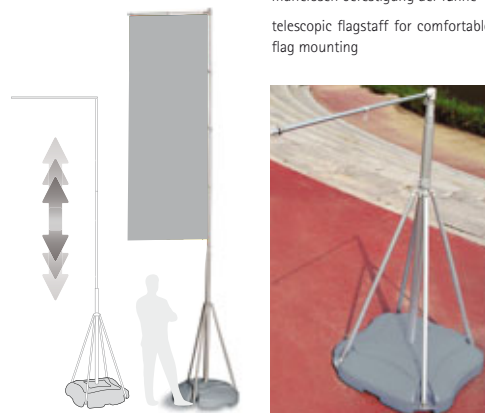

tripole & giantpole

MADE IN SOUTH KOREA quality control by KD

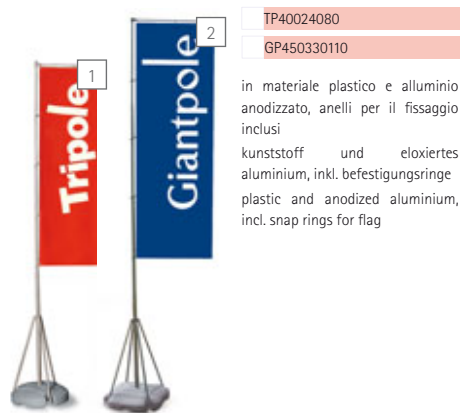

TP40024080
 GP450330110

in materiale plastico e alluminio anodizzato, anelli per il fissaggio inclusi
 kunststoff und eloxiertes aluminium, inkl. befestigungsringe
 plastic and anodized aluminium, incl. snap rings for flag

IT sono mobili ma robusti e con un'altezza rispettivamente di 5,4 mt (giantpole) e 4 mt (tripole) si fanno proprio notare. non importa che sia per manifestazioni sportive, eventi culturali, fiere, convegni o promozioni pubblicitarie, giantpole e tripole creano un bel colpo d'occhio. l'asta per la bandiera e i sostegni laterali sono in alluminio anodizzato. la base in materiale plastico può essere riempita di acqua o di sabbia. quando la base è riempita completamente, giantpole e tripole possono essere utilizzati all'esterno con un vento massimo di 14m/s (50,4 km/h). inserire il portabandiera sulla base, attaccare la bandiera, allungare l'asta e il gioco è fatto. base e asta non sono vendibili singolarmente.

DE mobil, stabil und robust sind giantpole und tripole. bei einer höhe von 5,4m (giantpole) bzw. 4m (tripole) fallen sie ganz sicher auf. egal ob sportveranstaltung, kulturevent, messe oder werbeaktion, die mobilen giant- und tripole sind ein echter hingucker. fahnenstange und gestänge sind aus eloxiertem aluminium. die kunststoff-basis kann mit wasser oder sand gefüllt werden. mit gefüllter basis halten giant- und tripole windgeschwindigkeiten bis zu 14m/s (50,4km/h) stand. gestänge in die basis stecken, fahne befestigen und den mast ausziehen, fertig. basis und mast können nicht einzeln bestellt werden.

EN mobile, stable and robust are giantpole and tripole. with 5,4m (giantpole) and 4m (tripole) you will attract attention for sure. whether sporting or cultural events, fairs, open houses or sales promotions, the mobile giant- and tripole will catch everybody's eye for sure. pole and bars are made of anodized aluminium. the plastic base can be filled with water or sand and when filled giant- and tripole withstand wind speed up to 14m/s (50,4km/h). set base and pole together in no time. mount the flag and extend the telescopic flagstaff, that's it.

	giantpole	tripole
asta - mast - pole	min. 1600mm max. 5400mm	min. 1500mm max. 4000mm
base - basis - base	800x800x200mm	650x650x200mm
asta - mast - pole	5,9kg	2,9kg
base - basis - base	5,0kg / 70 lit.	3,0kg / 45 lit.
bandiera - fahne - flag standard mm	1100x3300mm	800x2400mm
bandiera - fahne - flag max. mm	1100x3900mm	800x2900mm
bandiera - fahne - flag max. kg	1000g	800g

tripole & giantpole



n° articolo | artikelnr. | product nr.

1	TP40024080	tripole set, 1pc	245,00€
2	GP450330110	giantpole set, 1pc	365,00€



1
pirata
369,-

flag not included



pirata

MADE IN EU quality control by KD

- larghezza dell'orlo 80 mm per il tubo di Ø 40mm
- max. 1m
- moschettoni per i tiranti sull'asta
- saumbreite 80mm für rohr Ø40mm
- max. 1m
- karabinerhaken für gurtschlaufen
- flag border 80mm for tube Ø40mm
- max. 1m
- carabiner hooks for straps

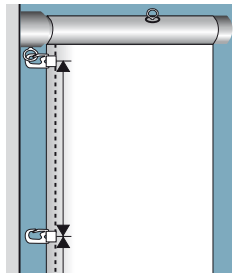

IT asta portabandiera cilindrica con dispositivo interno per issare la bandiera, braccio girevole telescopico, adatta per essere interrata nel cemento. la bandiera viene issata verticalmente sull'asta grazie ai tiranti. peso antisollevamento. riavvolgimento della bandiera facile e veloce. alluminio anodizzato di alta qualità in colore argento. dimensioni consigliate della bandiera: 3000x1200mm.

DE zylindrischer fahnenmast mit innenliegender, abschliessbarer hissvorrichtung und hissbarem, teleskopischem drehausleger, bodenhülse zum einbetonieren, vertikale fahnetuchführung durch gurtschlaufen am mast, gewicht gegen hochwehen und leichtes einholen der fahne, aus hochwertigem silber eloxiertem aluminium. empfohlenes fahnenmaß: 3000x1200mm.

EN cylindric flagpole mit internal, lockable winch and telescopic, turnable flag arm. flag arm can be taken up and down. flying sleeve to set in concrete, vertical guidance of the flag on the pole, weight to protect the flag from flying up and to take it easily down. made of high-grade silver anodized aluminium. recommended flag size: 3000x1200mm.

pirata



n° articolo | artikelnr. | product nr.
1 DFP6000A *)
pirata flagpole, 1pc 369,00€

*) spedizione extra per merce voluminosa, non può essere consegnata assieme ad altri prodotti.
*) extra sperrgut-versand, kann nicht mit anderen artikeln versandt werden.
*) extra bulk material transport, cannot be shipped together with other items.

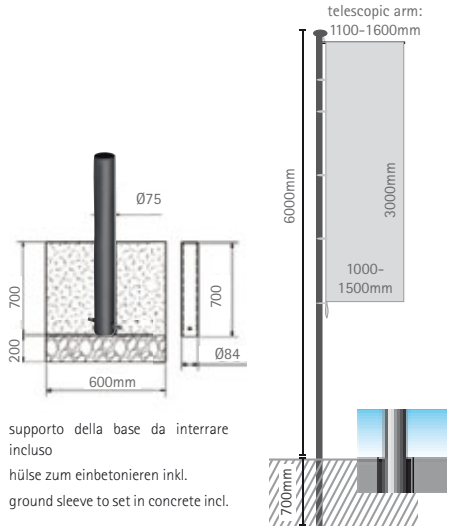

supporto della base da interrare incluso
hülse zum einbetonieren inkl.
ground sleeve to set in concrete incl.

digii



print not included

2
pylo 1900x600mm

645,-

- SOPYO1900400 1
- SOPYO1900600 2
- SOPYO1900800 3

profili e pannelli: alluminio anodizzato color argento, angoli in pressofusione, anche da terra in ferro zincato.

profile und paneel: silber eloxiertes aluminium, verbinder veredelter aluminiumdruckguss, bodenhülse eisen verzinkt

panel and profiles: silver anodized aluminium, connectors plated die cast aluminium alloy, ground sleeve zinced iron

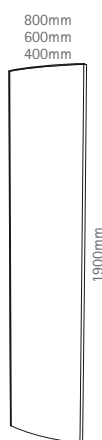

IT pylo outdoor è concepito e realizzato appositamente per l'esterno: a seconda della collocazione, la struttura può essere interrata, ancorata o cementata al suolo. i pannelli in alluminio possono essere stampati o decorati con pellicole, prespaziati, vinili, ecc. i pannelli, così come i profili in alluminio anodizzato e gli angoli stampati a pressofusione, sono di alta qualità e duraturi nel tempo. pylo outdoor è disponibile in tre differenti larghezze.

DE pylo outdoor ist speziell für den aussenbereich gemacht: die bodenhalterung wird je nach untergrund angeschraubt oder einzementiert. die aluminium-paneel können sie je nach anforderung bedrucken oder kaschieren. sie sind wie die ebenfalls silber eloxierten aluminiumprofile sowie die veredelten metalldruckguss-ecken hochwertig und langlebig. erhältlich ist der pylo outdoor in drei verschiedenen breiten.

EN pylo outdoor is made especially for outdoor use: the ground sleeve can be fixed with screws or concrete according to your underground. the silver anodized aluminium panels can be printed or laminated. like the silver anodized profiles and the plated zinc aluminium aloy die-cast connectors they are robust and durable. the pylo outdoor is available in three different sizes.

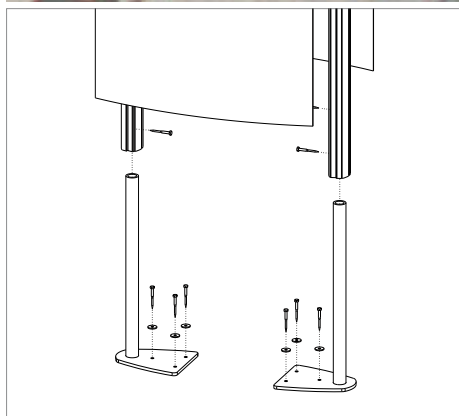

pylo outdoor

n° articolo | artikelnr. | product nr.

1	SOPYO1900400	pylo outdoor 1900x400mm , 1pc	544,00€
2	SOPYO1900600	pylo outdoor 1900x600mm, 1pc	645,00€
3	SOPYO1900800	pylo outdoor 1900x800mm, 1pc	704,00€

in vendita da febbraio 2011 | auslieferung ab februar 2011 | on sale from february 2011



- 3 IP1900400ARW
- 4 IP1900600ARW

profili in alluminio anodizzato color argento, base metallica verniciata a polvere color argento, pannelli di alluminio composito color bianco opaco e argento, angoli in zamac color argento

silber elox-aluminium profil, basis metall silber pulverbeschichtet, alu-verbundpaneel mattweiss/silber, eckverbinder versilberter metall-druckguss

silver anodized aluminium extrusion, base silver coated metal, aluminium composite panel matt white/silver, edge connectors silver-plated die-cast metal

ipoint

MADE IN EU design by KD



IT ipoint è il pratico totem fornito completo di due pannelli in alu bond colore argento e bianco opaco per la stampa digitale che vi permetterà di creare la vostra grafica sia sul fronte che sul retro. a scelta si possono aggiungere ripiani, accessori o altri moduli ipoint dalla linea soistes. chiedeteci e noi saremo sempre a disposizione per darvi ulteriori idee ed informazioni.

DE ipoint liefern wir ihnen mit zwei doppelseitigem alu-verbundpaneel: silber und weiss matt für digitaldruck. sie können so selbst entscheiden wie sie jeweils die vorder- und auch die rückwand ihres ipoint gestalten. optional lassen sich ablagen, display bars oder weitere ipoint flächen ergänzen. fragen sie uns, wir beraten sie gerne.

EN ipoint is provided with two double side aluminium composite panels: satin silver and matt white for digital printing. thus you can freely design front and rear side of your ipoint. optionally you can add trays, display bars or further ipoint modules. just ask us, it is our pleasure to provide you with more ideas and further information.

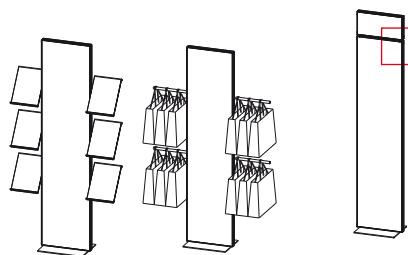

ipoint

n° articolo artikelnr. product nr.	structure	
1 IP1900400ARW	ipoint 1900x400 silver/weiss, 1pc	308,00€
2 IP1900600ARW	ipoint 1900x600 silver/weiss, 1pc	397,00€
accessory		
3 IPTCON	ipoint connector, set 2pcs	10,20€



1
ipoint 1900x400
308,-

print not included

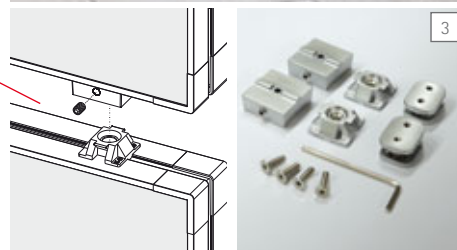

3
IPTCON
connettore per strutture ipoint in zamac color argento
verbinder für ipoint strukturen, versilberter metall druckguss
connector for ipoint structures, silver plated die-cast metal

dig



monsterframe

 MADE IN EU design by KD



M
for **BIG- and**
GIGAPRINTS

IT monsterframe per stampe giganti: IL prodotto giusto per le vostre MEGA stampe pubblicitarie out-of-home. sistema di fissaggio semplice da usare, per fissare banner pubblicitari in pvc o vinile in ambito interno ed esterno. design all'avanguardia e alta qualità caratterizzano monsterframe. il sistema di fissaggio del banner è davvero intelligente: basta inserire i buttons nella cava del profilo. i buttons possono essere cambiati in ogni momento, anche dopo il montaggio. il banner quindi può essere appeso facilmente da UNA sola persona, senza bisogno di smontare l'intera struttura e senza l'uso di speciali attrezzi. per il fissaggio stesso del banner ci sono a disposizione varie possibilità. nelle prossime pagine potrete trovare altre informazioni!

DE monsterframe für gigaprints: DAS produkt für ihre BIGprints im out-of-home marketing. anwenderfreundliches befestigungssystem für werbebanner von pvc-plane bis netzvinyl im außen- und innenbereich. patente design- und produktqualität zeichnen monsterframe aus. alle teile sind robust, langlebig, hochwertig und wiederverwendbar. besonders clever ist die bannerbefestigung. bannerbuttons werden einfach in die rückseitige profilnut eingesetzt. die buttons können jederzeit - auch nach der montage - eingesetzt oder entnommen werden. das banner kann dadurch von EINER person, OHNE demontage des rahmens und OHNE werkzeug auf- und abgehängt werden. für die bannerbefestigung selbst stehen gleich mehrere möglichkeiten zur auswahl. auf der nächsten seite finden sie mehr!

EN monsterframe for giga prints: THE product for your BIG prints in the out-of-home marketing sphere. user-friendly in- and outdoor mounting system for advertising banners made of pvc or net vinyl. smart design and high-grade quality is what monsterframe stands for. all parts are robust, durable, top-quality and reusable. the banner mounting is especially clever. the buttons are simply inserted into the profile's notches. buttons can be replaced at anytime - even after-mounting. the banner can be hung up and taken down by ONE person, with NO demounting and NO tools. for the banner's mounting itself we have several clever possibilities. check out more on the following page.



MF MUS600500
campione per showroom
completo di banner
showroom muster mit banner
sample for your showroom with
banner

n° articolo | artikelnr. | product nr.

1 **MF MUS600500**

sample monsterframe, 1pc

89,00€



angoli in alluminio stampato con verniciatura a polvere color argento
eckverbinder aus aluminium druckguss mit silber pulverlackbeschichtung
corner bracket made of aluminium die-cast silver powder coated.



inserire e fissare con vite
einschieben und mit gewindestift sichern
insert and fix with screw



inserire i buttons nella cava del profilo
banner buttons in die rückwärtige profilnut einsetzen
insert banner buttons into the rear notch of the profile



esercitare una rotazione di 90°
drehen um 90°
turn 90°

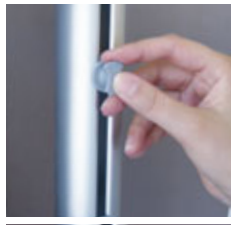

pronto e sicuro per il montaggio del banner
sicher befestigt für die bannermontage
securely fastened for banner mounting



fissaggio sicuro con supporti in alluminio adatti per interno ed esterno

wandbefestigung mit wetterfestem aluminium schellen für innen und aussen

wall mount with weather-proof aluminium couplers for in- and outdoor





monsterframe

patented

MADE IN EU design by KD



MFP1100AL	1100mm
MFP2100AL	2100mm
MFP3100AL	3100mm

MFP4100AL	4100mm
MFP5100AL	5100mm

1-5

profilo in alluminio anodizzato Ø50mm, pretagliato, conf. 1 pz.
 silber eloxierte aluminiumprofile Ø50mm, montagefertig abgelängt, je 1 stange.
 silver anodized aluminium extrusion Ø50mm, 1bar, precutted.

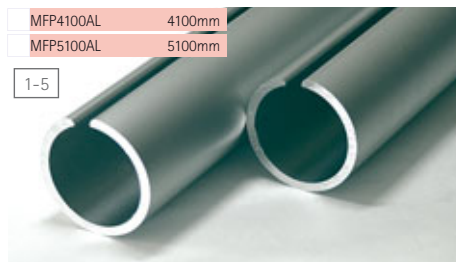

MFA110AR
 angoli stampati in alluminio, verniciati in color argento, 4 pz.
 eckverbinder alu druckguss, silber pulverlack beschichtet, 4stk.
 corner connector aluminium diecast, silver metallic coated, 4 pcs.



MFTANG02
 connettore a T in metallopressofuso color argento, per composizioni modulari e sempre nuove del vostro monsterframe
 t-verbinder für modulare gestaltung der monsterframes aus metalldruckguss silber lackiert
 t-connector for modular composition of the monsterframe, zamac die-cast, silver metallic coated



MFV400AL
 connettore per profili in alluminio stampato con verniciatura a polvere, lunghezza 200mm, conf. da 2 pz.
 profilverbinder aus metalldruckguss, länge 200mm, set mit 2 stk.
 profile connectors in powder coated moulded aluminium, length 200mm, pack with 2 pcs.

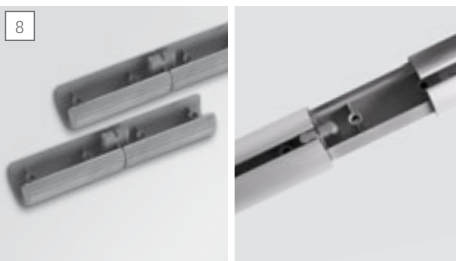

MFWH03AL
 fissaggio murale con aggancio in alluminio munito di 3 fori per il fissaggio a parete, materiale per il montaggio incluso, conf. 2 pz
 wandschelle, 3-punkt befestigung, aluminium für innen und aussen, mit montagematerial set 2 stk.
 wall mounting support with 3 point fixing, made of aluminium, incl. mounting material, pack with 2 pcs.



MFWH01AL
 fissaggio murale con aggancio in alluminio munito di un foro per il fissaggio a parete, materiale per il montaggio incluso, conf. 2 pz
 wandschelle, 1-punkt befestigung, aluminium für innen und aussen, mit montagematerial set 2 stk.
 wall mounting support with 1 point fixing, made of aluminium, incl. mounting material, pack with 2 pcs.

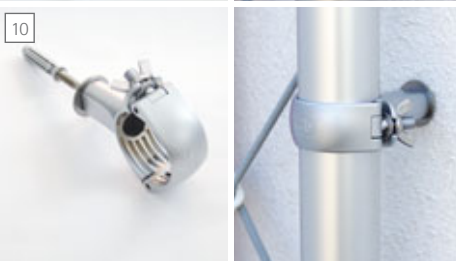

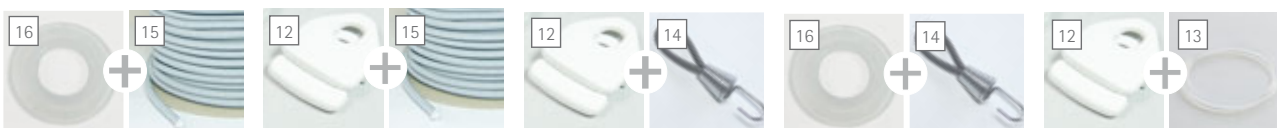

IT i profili di questo sistema modulare sono disponibili sia in lunghezze standard che lunghi 6.5 m, per essere poi tagliati a piacere. per il fissaggio sono disponibili fissaggi in alluminio, bannerbuttons e pratici occhielli, elastico grigio ed elastici con ganci. tutto quello di cui avete bisogno per il vostro monsterframe è disponibile in internet su www.frame-tool.com, dove troverete un pratico programma con il quale potrete configurare esattamente ed in pochi click il vostro monsterframe. il tool vi preparerà una lista di acquisto di tutti i pezzi necessari, che potrete spedire via fax al vostro rivenditore. tutti i pezzi sono robusti, durevoli nel tempo, di alta qualità e riutilizzabili.

DE das modulare stecksystem ist in standardlängen oder als stangenware zum selberschneiden erhältlich. für die befestigung finden sie aluminiumschellen, bannerbuttons sowie praktische ösen, gummikabel und expander. was sie alles für ihren monsterframe brauchen, können sie ganz einfach im internet unter www.frame-tool.com berechnen. dort finden sie einen praktischen rechner, mit dem sie ihren monsterframe massgenau mit wenigen clicks konfigurieren. das tool stellt ihnen dazu die richtige einkaufsliste für alle teile zusammen. diese liste faxen sie dann direkt an ihren händler. alle teile sind robust, langlebig, hochwertig und wiederverwendbar.

EN the profiles for this modular system are available in standard lengths or, order 6.5m profiles and machine cut them to your own specifications. for mounting you'll find aluminium supports, banner buttons and eyelets, elastic cords and expanders as well. everything you need for your monsterframe can easily be figured out with the calculator on the website www.frame-tool.com. with this virtual tool you can configure your frame with just a few clicks. the tool prepares your purchase list for all the parts needed. you can print and fax this list directly to your retailer. all parts are robust, durable, high-quality and reusable.



www.frame-tool.com

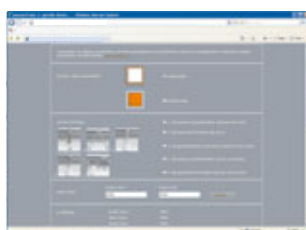

monsterframe

n° articolo | artikelnr. | product nr.

1	MFP1100AL	profile, 1100mm, 1pc	25,50€
2	MFP2100AL	profile, 2100mm, 1pc	47,50€
3	MFP3100AL	profile, 3100mm, 1pc	70,00€
4	MFP4100AL	profile, 4100mm, 1pc	92,50€
5	MFP5100AL	profile, 5100mm, 1pc	113,50€
6	MFA110AR	corner connector, 4pcs	39,00€
7	MFTANG02	t-connector, 2pcs	46,00€
8	MFV400AL	cross connector, 2pcs	27,00€
9	MFWH03AL	3 point wall mounting support, 2pcs	49,50€
10	MFWH01AL	1 point wall mounting support, 2pcs	42,00€
11	MFTP22GR	banner buttons, 20pcs	8,00€
12	ACL3540WE	clamp for banner, 20pcs	20,00€
13	AGK60TR	elastic ring, 20pcs	25,75€
14	AGK30GR	elastic expander, 20pcs	48,00€
15	MFGK06GR	elastic rope, 50m	77,50€
16	AEY3012TR	eyelet in polypropylene, 50pcs	36,10€

MFTP22GR

banner buttons per fissaggio banner, grigi, conf. da 20 pz.

banner buttons für die montage des banners, grauer kunststoff, packung mit 20stk.

buttons for mounting grey synthetic, pack with 20 pcs.



ACL3540WE

clamp gancio istantaneo, non occorre forare i tessuti, riutilizzabile.

clamp bannerklemme für befestigung ohne öse oder loch, wiederverwendbar, hält auf zug, box 20stk.

clamp for banner white, holds without holes or eyelets, reusable, box 20pcs.



AGK60TR

anello trasparente elastico Ø60mm, materiale: silicone

gummiring transparent Ø60mm, material: silikon

plastic transparent rings Ø60mm made of silicon



AGK30GR

elastico con gancio grigio Ø30mm, in materiale PES, gancio zincato, conf. da 20pz.

gummixpander grau Ø30mm, material PES, haken verzinkt, packg. 20st.

elastic expander grey Ø30mm, made of PES, hook zincplated, box 20pcs.



MFGK06GR

elastico grigio Ø6mm, in materiale PE, rotolo 50m

gummikabel grau Ø6mm, material PE, rolle mit 50m.

elastic rope grey, Ø6mm, made of PE, roll 50m.



AEY3012TR

occhielli con chiusura a scatto. mat.: polipropilene bianco. dimensioni: interno Ø12mm, esterno Ø30mm, conf. da 50pz.

ösen mit schnappmechanismus. mat.: polypropylen, weiss. grösse: innen Ø12mm, aussen Ø30mm. packg. 50st.

snapping eyelet. mat.: polypropylene, white. size: inside Ø12mm, outside Ø30mm. box 50pcs.



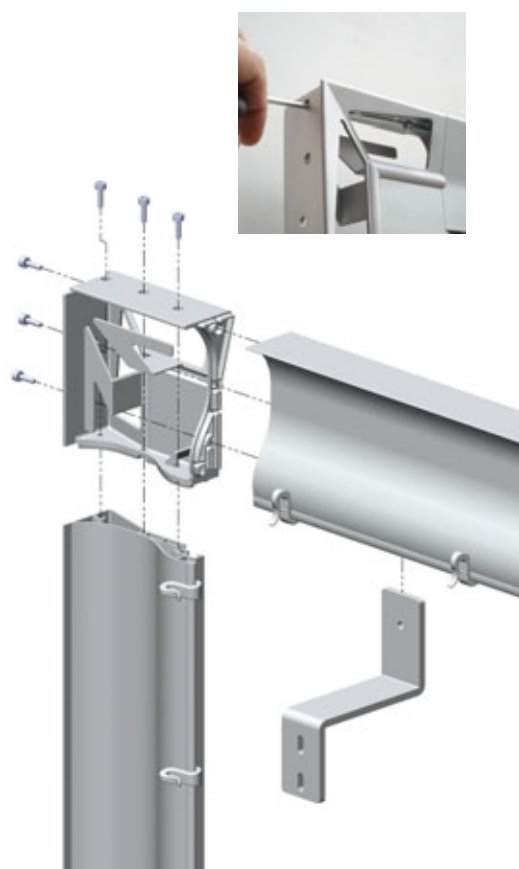

angelframe

patented

MADE IN EU design by KD



1-4

AFP1000AL (1m)	740mm
AFP2000AL (2m)	1740mm
AFP3000AL (3m)	2740mm
AFP4000AL (4m)	3740mm

alluminio anod. argento, misure per lunghezza visibile 1-4m o per taglio silber elox-alu, längen für banner-sichtfläche 1-4m oder meterware silver anod. aluminium, size for visible length 1-4m or meter to cut



5

AFWHD01
fissaggio a muro, metallo zincato, incl. materiale di montaggio, 1pz
wandhalter metall verzinkt, inkl. montage-material, 1st.
wall mounting support, galvanised metal, incl. mounting material, 1pc



6

AFANO4AR
angoli in zamac color argento, 4pz
eckverbinder metalldruckguss versilbert, 4st.
corner connector metal die-cast, silver coated, 4pcs

IT angelframe rimane discreto ed invisibile nella parte posteriore delle vostre stampe digitali di grande formato, dandovi così la possibilità di esporre le vostre presentazioni senza cornici laterali. gli angoli vengono avvitati direttamente, e quindi in modo decisamente sicuro, sui profili; per questo motivo non c'è bisogno di tagliare i profili a 45°. dadi e clip per banner possono essere inseriti nel profilo anche dopo aver effettuato il montaggio. il bordo del banner viene agganciato alla parte posteriore del profilo: il fissaggio posteriore vi permette di nascondere facilmente eventuali irregolarità del banner. il montaggio di angelframe vi farà risparmiare tempo e denaro: lo stesso cambio del banner, grazie al design e alla funzionalità intelligente, è facile, veloce e attuabile senza l'utilizzo di utensili.

DE angelframe hält sich bei den large-formats dezent unsichtbar im hintergrund und präsentiert ihr big-format rahmenlos. die ecken werden direkt und damit besonders stabil mit dem profil verbunden. profile können gerade und ohne gehrung geschnitten werden. die nutsteine lassen sich einklicken, ebenso wie die bannerclips, d.h. auch schon montierte rahmen können noch ergänzt werden. der bannerrand wird über das rahmenprofil gezogen und bleibt unsichtbar. ungenauigkeiten bei zuschnitt oder säumung fallen damit nicht mehr auf. insgesamt ist die montage zeit- und kostensparend, ebenso der banner-austausch ist durch das clevere design unkompliziert und ohne werkzeug jederzeit möglich.

EN angelframe is backstage when it comes to presenting large-formats. the structure holds your banner framelessly, the edges are directly and firmly connected to the extrusions so it is not necessary to mitre the profiles. the threads for wall fixing and the banner clips can be clicked in to place even after mounting. the banner seam is pulled over the frame profile, thus hiding imprecise cuts or seams. all in all, the mounting saves time and money, the banner exchange is easy and does not require tools and is possible at anytime.

frame length = profile + 260mm

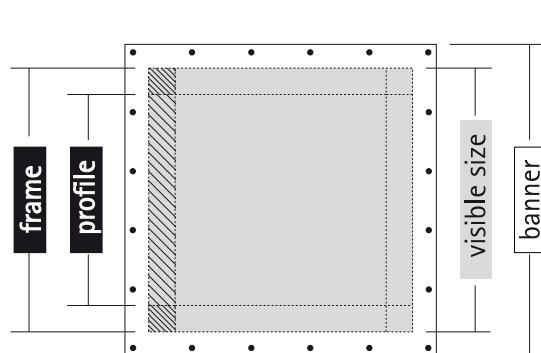

banner = visible size + 160mm



montare il gancio a parete, fissare i dadi nel profilo - siccome non vengono inseriti nella cava, è possibile aggiungerne anche dopo aver terminato il montaggio della struttura. fissare il profilo al gancio. distanza dalla parete del banner: 130mm

montage der wandhalterung, nutstein einklicken - da kein einschub, ist das auch nach (!) erfolgter montage möglich - profil montieren. wandabstand banner: 130mm

mount the wall support, click in the washer - thanks to this you can click in more washers also after (!) mounting - fix the profile. wall distance for banner: 130mm

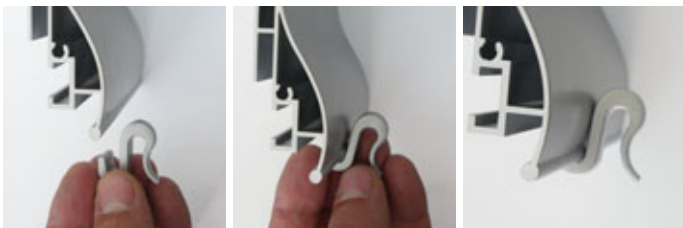

agganciare le clip al profilo, nella quantità desiderata, prima o dopo il montaggio della struttura; gancio per elastico che ne semplifica l'assemblaggio e lo mantiene perfettamente in tensione.

banner clips einfach ans profil klicken, jederzeit und so viele wie nötig, auch nach der montage. mit führung für das gummikabel: erleichtert das spannen und verhindert herausrutschen.

simply click the clips to the profile, anytime and as many as you need, even after assembling of the structure. with channel for the elastic cord: eases the tightening of the cord and prevents it from slipping out.



montaggio ad angolo del banner senza pieghe : funzionalità intelligente fin nei più piccoli dettagli. gli angoli sono provvisti di scanalature nelle quali inserire agevolmente il banner. in questo modo potrete tensionare il vostro banner comodamente e facilmente.

faltenefreie eck-montage: cleveres design auch hier. die eckverbinder habe eine nut, in die sie einfach die bannerecken ziehen. so spannen sie ihr banner im nu faltenefrei und sauber!

crease free mounting of the angles: the clever design provides a solution as well. all the edge connectors come with a slot where you simply pull through the banner ends. thus you tighten your banner quickly crease free and neat!



il connettore angelframe, per composizioni modulari, deve essere fissato ad un gancio murale. i profili risulteranno così connessi grazie a questo accessorio.

der connector für die modulare gestaltung muss an einer wandhalterung angebracht werden. die profile werden mittels connector verbunden.

the connector for modular design of angelframe must be mounted directly to the wall mounting support. the profiles can then be connected directly.

angelframe

n° articolo | artikelnr. | product nr.

1	AFP1000AL	for 1m visible banner length, profile 740mm, 1pc	23,00€
2	AFP2000AL	for 2m visible banner length, profile 1740mm, 1pc	50,00€
3	AFP3000AL	for 3m visible banner length, profile 2740mm, 1pc	78,00€
4	AFP4000AL	for 4m visible banner length, profile 3740mm, 1pc	105,00€
5	AFWHD01	wall support, 1pcs	18,00€
6	AFAN04AR	edge connector, 4pcs	66,00€
7	AFCON02	angelframe connector, 2pcs	19,50€
8	AFC20GR	banner clips, 20pcs	8,50€

AFCON02

connettore in alluminio stampato con verniciatura a polvere 2pz

verbindungsstück aus metalldruckguss, 2st

connector in powder coated moulded aluminium 2pcs



AFC20GR

banner clips, nylon color grigio, 20pz

banner clips, nylon grau, 20st

banner clips, grey nylon, 20pcs

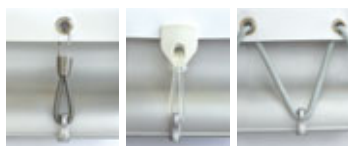

come per monsterframe, il sistema angelframe vi offre varie possibilità per il fissaggio del banner al profilo, si veda pag. 157

gleich wie monsterframe hat auch der angel diverse bannerbefestigungsmöglichkeiten, mehr auf s. 157

like monsterframe angel has also different possibilities to fix the banner. see p. 157 for more details